



Experience The
Excellence

AQUTOP CERAMIC
MFG. SANITARYWARE

Nr. Toll Tax, Morbi - Wankaner - Highway, Waghasiya,
Ta. Wankaner, (Guj.) INDIA.

info@aquatopceramic.com, export@aquatopceramic.com

www.aquatopceramic.com



Scan & Download
E-Catalogue



Scan & Visit
Website



sfumato grafica +91 90990 25891

COLLECTION 2020-21





Modern

Handicraft

When it's about pure trust and accountability,
a finest handcrafted skill is required.

Wall Hung

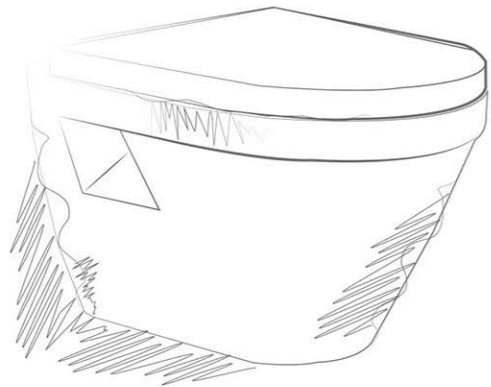

One Piece Closet



Table Top

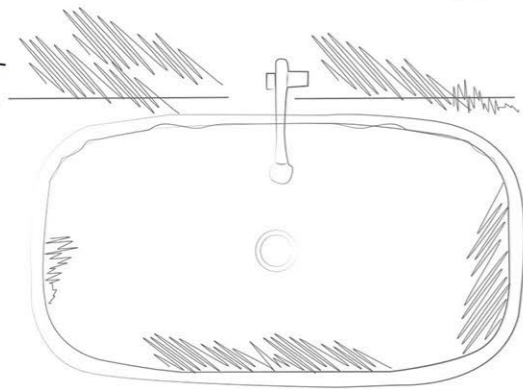

—
trust our
Handcrafted Luxury

ABOUT US

When it's about the icons and pioneer engineering work in sanitary ware products our name comes first.

Aqutop Ceramic, a 25 years of experience in the manufacturing of sanitary ware and ceramic products. With our innovation and expertise produce a finest sanitary ware products that give excellent solutions to your bathroom.

A seamless bath space solutions for our all consumers seeking for a newly well designed bath space. An excellent and stylish elegant bath design that everyone dream about it.

With cutting edge technology and new generation challenges we take this as new opportunity to gives a unique and complete solution that give 100% satisfaction.

Giving excellent products and services that made customer satisfied is the foundation of the Aqutop Ceramic. Aqutop ceramic always believes that satisfying the customer is the part of the it's success journey. Making success journey with customer is one of the milestones that every organization seeks.



More than 2 decades, we Aqutop ceramic made innovative products, invested in technology & research, identified needs of our customer. All these give us a huge success that drive our brand name across the globe. With corporate culture and excellent management Aqutop ceramic have built a strong foundation that helps to accept any challenge for the next decades.

As having 25 years of manufacturing experience we have supported complex projects to architectural level design project that became icon of modern world. Inspired by the most traditional art work to the craftsmanship of unique scriptural, we have made a classic and stylish products.

As we experience excellent journey of success we also expand our presence across the globe and identify new opportunities to become icon of ceramic and sanitary ware markets. With our quality products and excellent services it leads us in the different countries and gives support to construction and architectural projects.

PRODUCTION & QUALITY

Raw material

To make finest sanitary ware products it requires a quality and standard inspection of raw materials. We Aqutop Ceramic have made a standard quality bench mark to use raw material for making our finest iconic products.

With challenges in modern design we ensure that all raw material must go through complete quality procedure so it gives foundation of an excellent product. This brings out the true essence of sanitary ware products from Aqutop Ceramic.

Quality procedures

In our production line our Crafters follow all the quality procedure to ensure that our product becomes the centre of attraction. With certain quality criteria our products are one of the best & preferred in the market.

A quality process with visual reference that contain the trace of craft and shape to memorise the iconic Aqutop ceramic products and reinvent the theme of bath space design.

The right kind of quality service that's differentiate us from others Let our quality products exceed your expectations.

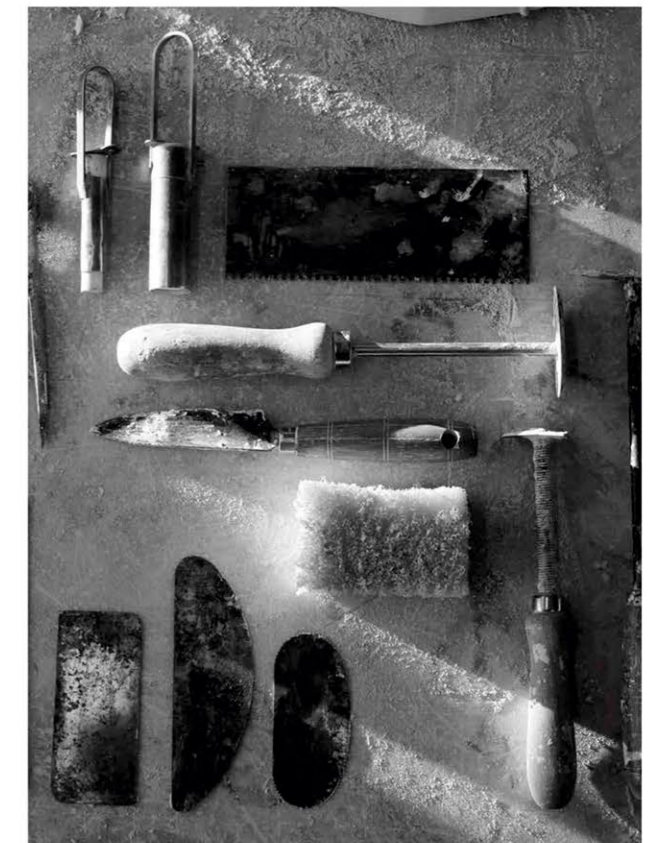

OUR PRESENCE IN WORLD WIDE

Global approvals & standards

Aqutop Ceramic is one of the reputed brands in international markets. By following international standards and norms, Aqutop Ceramic has vast presence world wide. With quality certificate that accepted at international markets we have made special name that recognised by its products.

With tremendous growth and excellence in ceramic industry it gives us an opportunity to add or give more values to the globe. Creating valuable resource for sanitary ware products that's support everyone needs over the globe.

Make in India Initiative gave us a huge opportunity to showcase our finest products to the rest of the world.



DESIGN & STYLE

Innovative and Original Design,

When innovation and creativity inspired by imagination, we craft a unique and special product that suits in your bath space.

We offer rapid 3d technology and latest software we can able to covert your vision into stylish reality with wide range of styles sanitary ware products that crafted with experienced person. Give taste of elegant designs to your bath space.



P R E M I U M
S A N I T A R Y W A R E

Connecting dots is the way of creating successful and artistic product that convert imagination to reality with latest 3d software we create an object exactly as we wanted.



As we get the raw format of our sanitary ware products with the help of software technology we can easily identify which material need to give exact look as need for bath space design.



It's time our crafters give the final appearance of our sanitary ware products to represent our iconic product to rest of the world.



EVOLUTION

Updated ergonomics

When we enter in 21st century a lot happens around the globe. People start changing their lifestyles & their needs. So we also change our mindset and start producing sanitary ware products that meets the need of today's generation .

As the genes changes, we also make changes in our products that suits their moods with accurate research and information we highly developed a product that is as comfortable as they wanted.

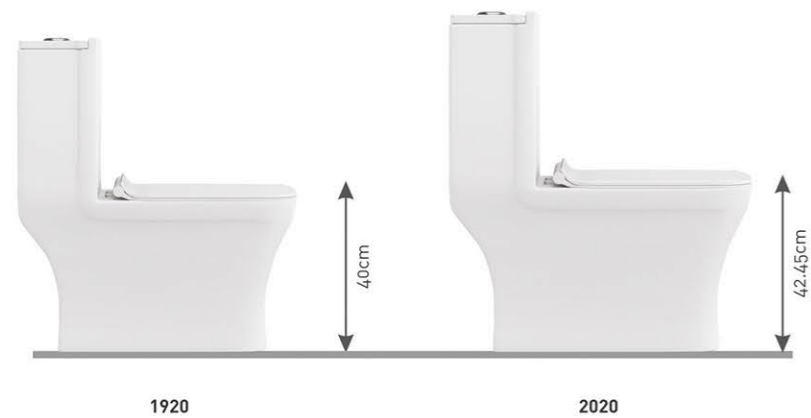

Comfort Height

As a decade passed away changes in the human body were also evolved in the timely manner with the help of research institute, we make sure that all the sanitary ware products are produce with the comfort level of the human body.

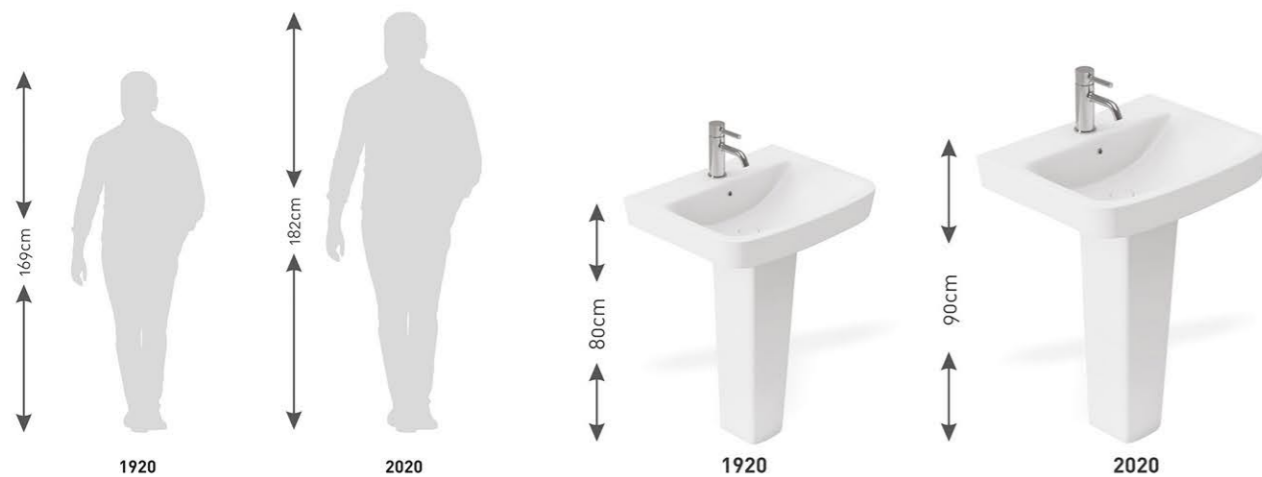

HIDDEN FIXATION

Hidden fixation system

Fully compatible with our installation systems, our sanitary ware products are secured to a robust steel frame installed behind the wall, leaving a seamless and elegant bathroom scheme with seamless installation using the hidden fixation system, fix any sanitary ware products on a wall in a faster way, in less time and easily

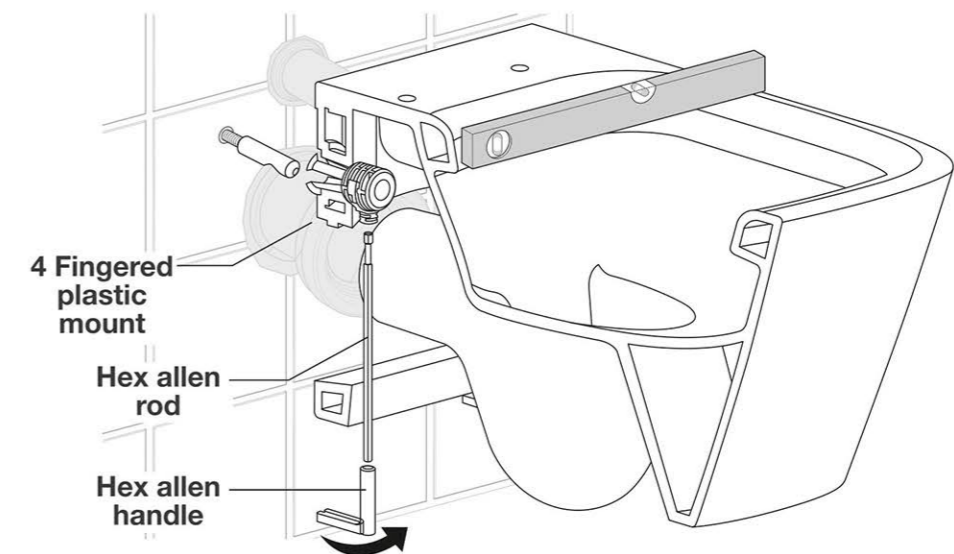

WATER SAVING

Can we save water in your bathrooms

Water is a precious element to our life. Our aim is to get maximum cleaning with less water. In our new research & development we successfully use less water that give more cleanness in our sanitary were product.

With this development we can save maximum water for future generations.

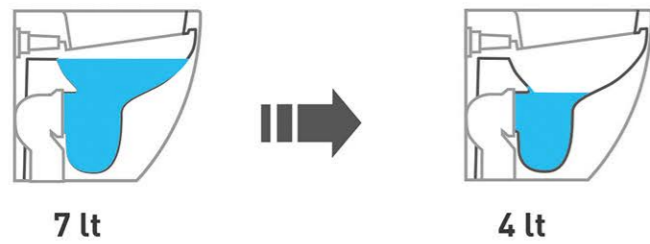

RIMLESS

The ultimate rimless technology for you bathroom

A rimless toilet made for significantly easier cleaning and a clear improvement in hygiene.

There is no build-up of bacteria and no possibility for limescale to lurk. The Rimless technology ensures quintessential hygiene with effective flushing that offers an efficient solution ensuring that the entire inner surface is rinsed throughout the flushing process.



TORNADO FLUSH

What is tornado flush?

Tornado Flush is an integral feature in new toilet. Instead of letting water pour down from the rim as in a traditional flush, the Tornado Flush projects three powerful jets of water from inside the bowl. This motion creates a whirlpool effect that cleans the entire surface.

It has been engineered so that the flushing water comes out at an angle creating a vortex or tornado-like suction. This provides a stronger force when flushing leaving you with a clean toilet every time

THE POWERFUL TOILET FLUSH



TORNADO FLUSH

When the water flows out the holes under the rim of the pan it comes out on an angle, not straight down. This allows the water to create a vortex inside the toilet pan. It does two things; it creates a far more powerful flush because of the force the spiraling water creates & it also washes the inside of the pan much better than any other flushing mechanism.

Need less water,
Get more clean



Cleanness in every
edge of the corner

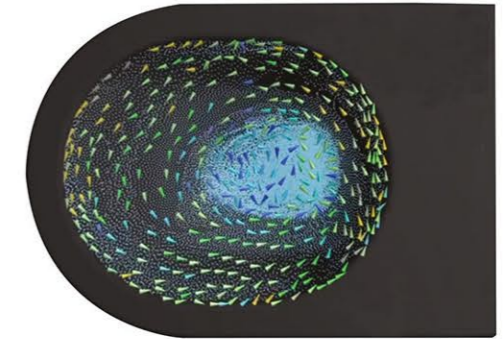



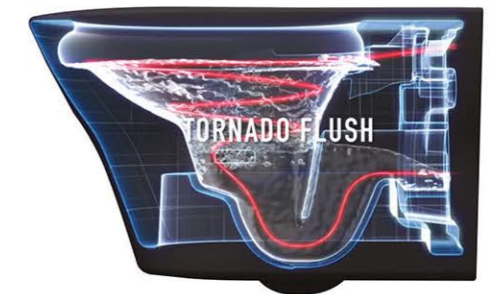

Today's innovation for
tomorrow's world

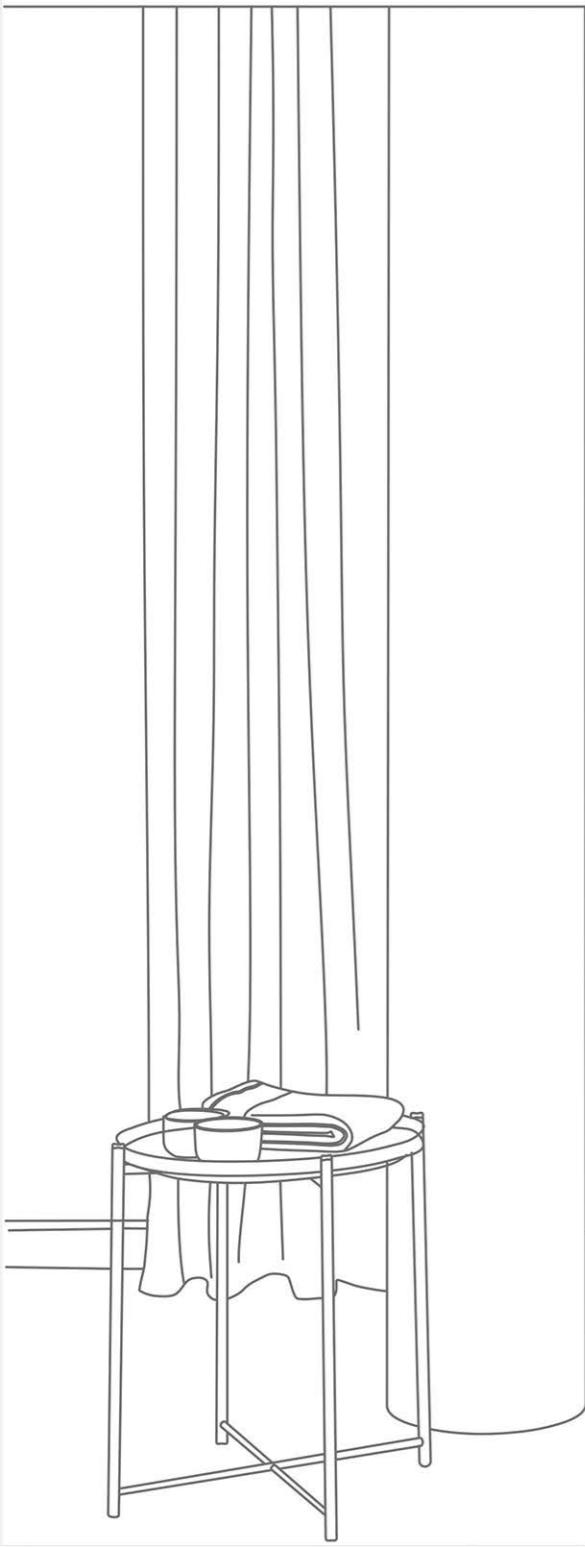

OUR COLLECTION

We create leading-edge products, by combining innovative solutions and excellence in terms of aesthetics and functionality. Our range is developed by soft molded shapes that slenders its impressive volumes. The products have easily adoptable to modern and classic ambience and have lovely ceramic gloss finishes.



-  Use of eco-friendly natural gas residues for better shine and luster
-  Production process according to ISI, ISO European standard
-  High-tempered firing with hygiene-friendly production process

01 / AQU SHADES

17 / ONE PIECE CLOSET

49 / WALL HUNG CLOSET

95 / TABLE TOP BASIN

139 / WASH BASIN

161 / ONE PIECE BASIN

171 / HALF & FULL PEDESTAL

193 / UNDER COUNTER BASIN

199 / FLOOR MOUNT EWC WATER CLOSET & ORRISA PAN

215 / URINAL

AVAILABLE COLOURS :  WHITE  IVORY

-  Each product radiates glossiness and whiteness
-  Use of finest raw materials - Purified, tested and certified by R&D
-  Use of advanced German technology with fully computerized controlled Shuttled Kiin
-  Water-saving flushing system with 7/4-litre knobs
-  Soft closing seat cover



MATTSeries

AQU *Shades*

BY AQU TOP

*Color has a power
which directly
influences the
soul and fill
the lives into
the world.*

*A living element
that drive
creativity and
innovation
of living style*



ROYAL BLUE



COMPACT

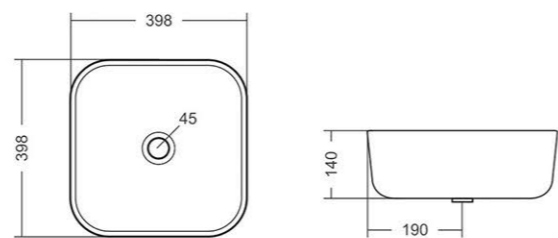
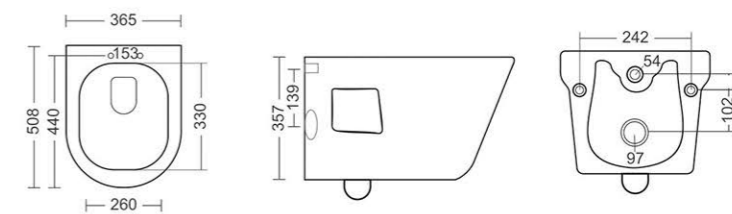

TABLE TOP BASIN
L398, W398, H140MM



RIGA



WALL HUNG CLOSET
RIMLESS
L508, W365, H357MM





MOUNT PEARL



COMPACT

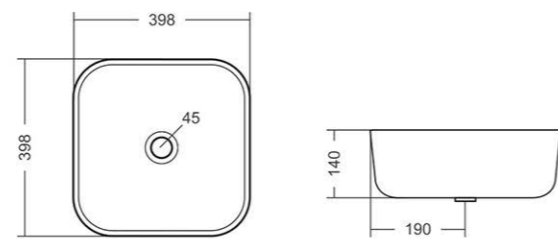
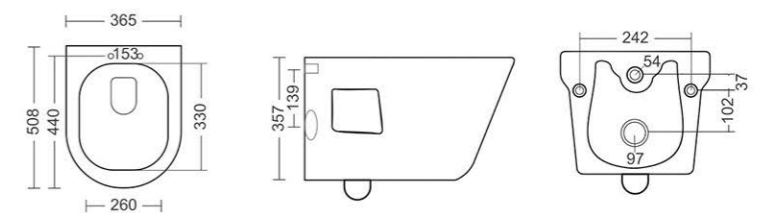

TABLE TOP BASIN
L398, W398, H140MM



RIGA



WALL HUNG CLOSET
RIMLESS
L508, W365, H357MM

7 RIMLESS

MATT WHITE



COMPACT

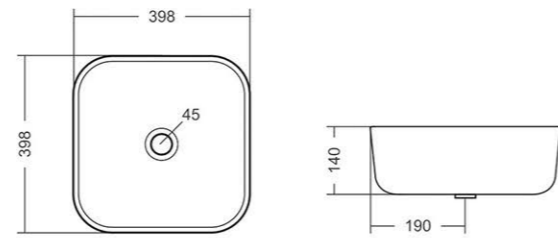
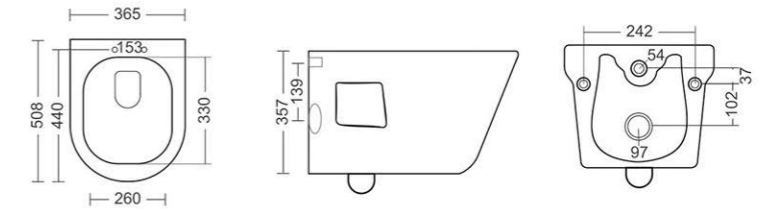

TABLE TOP BASIN
L398, W398, H140MM



RIGA



WALL HUNG CLOSET
RIMLESS
L508, W365, H357MM





LIGHT PINK



COMPACT

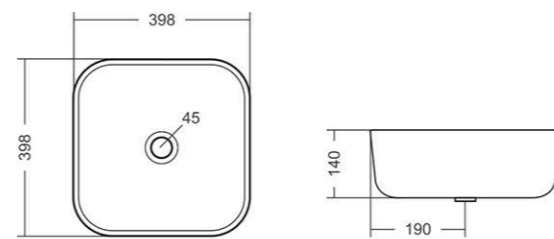
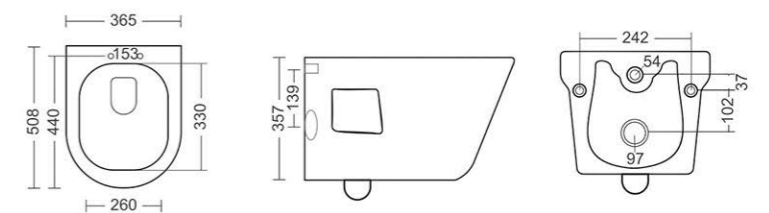

TABLE TOP BASIN
L398, W398, H140MM



RIGA



WALL HUNG CLOSET
RIMLESS
L508, W365, H357MM



LIGHT CREAM NATURE



COMPACT

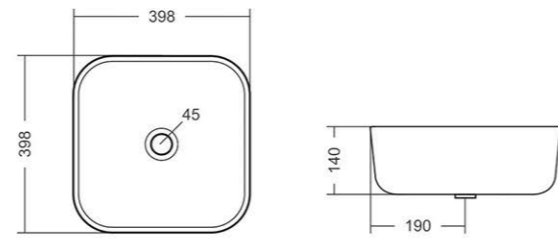
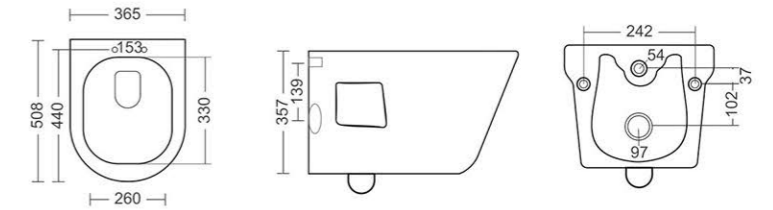

TABLE TOP BASIN
L398, W398, H140MM



RIGA



WALL HUNG CLOSET
RIMLESS
L508, W365, H357MM





BLACK PEARL



COMPACT

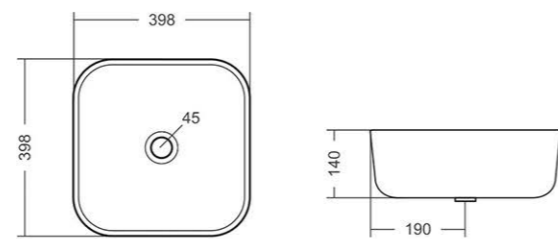
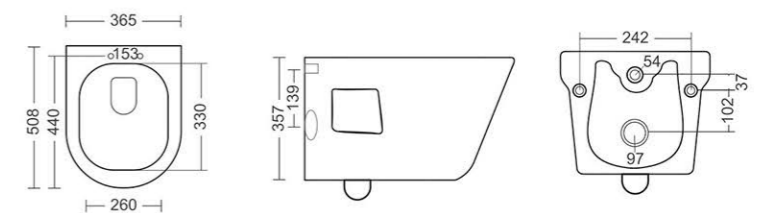

TABLE TOP BASIN
L398, W398, H140MM



RIGA



WALL HUNG CLOSET
RIMLESS
L508, W365, H357MM



ASIAN PEACOCK



COMPACT

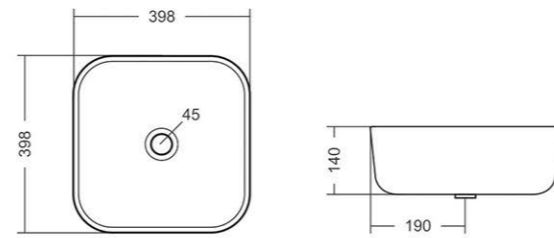
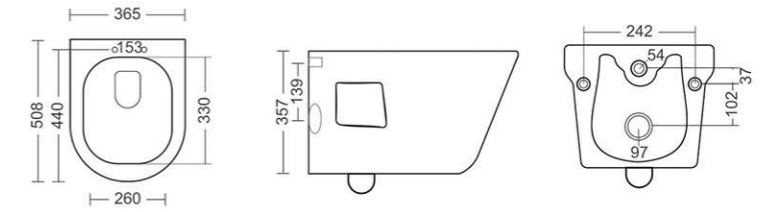

TABLE TOP BASIN
L398, W398, H140MM



RIGA



WALL HUNG CLOSET
RIMLESS
L508, W365, H357MM

7 RIMLESS





one piece
closet





Become center
of tomorrow's
world

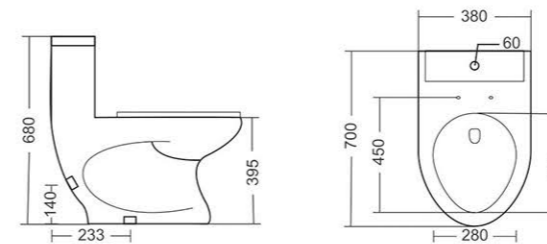

2002

ONE PIECE CLOSET
WASH DOWN FLUSHING

S-TRAP WALL DIST. 225MM

L700, W380, H680MM

Linear and
minimalist design



2003

ONE PIECE CLOSET
WASH DOWN FLUSHING

S-TRAP WALL DIST. 225MM

L662, W355, H725MM

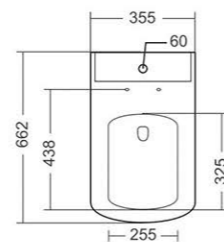
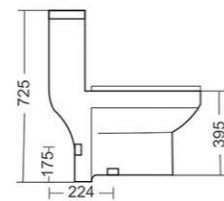



Perfectly blend
with the simplicity

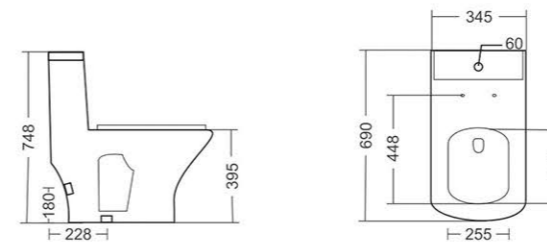

2004

ONE PIECE CLOSET
WASH DOWN FLUSHING

S-TRAP WALL DIST. 225MM

L690, W345, H748MM

Expressed through
the Luxury



2005

ONE PIECE CLOSET
WASH DOWN FLUSHING

S-TRAP WALL DIST. 225MM

L700, W375, H675MM

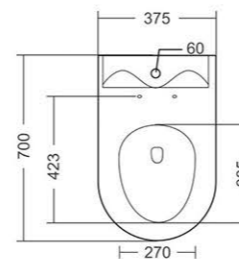
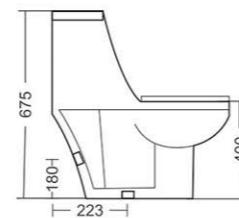



With simply
look and elegance

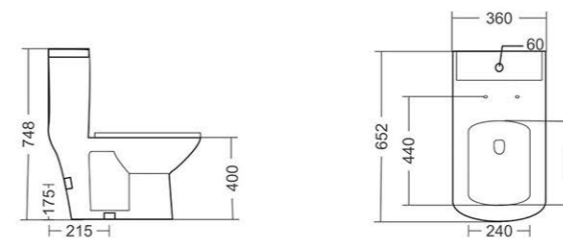

2006

ONE PIECE CLOSET
WASH DOWN FLUSHING

S-TRAP WALL DIST. 225MM

L652, W360, H748MM

Charming stylistic
detailing



2007

ONE PIECE CLOSET
WASH DOWN FLUSHING

S-TRAP WALL DIST. 100MM /255MM

L645, W345, H680MM

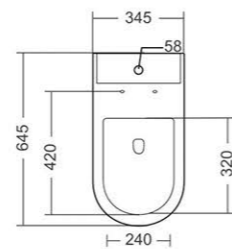
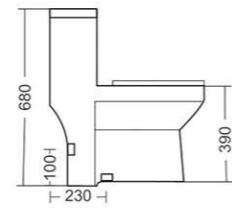



Feel immersive
experience

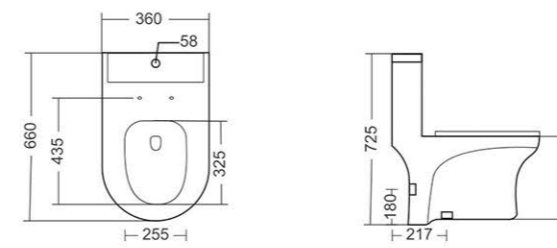

2008

ONE PIECE CLOSET
WASH DOWN FLUSHING

S-TRAP WALL DIST. 225MM

L660, W360, H725MM



2009

ONE PIECE CLOSET
SIPHONIC FLUSHING

S-TRAP WALL DIST. 225MM

L675, W365, H760MM

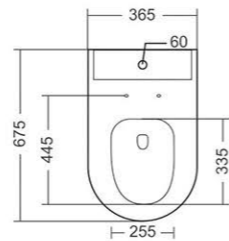
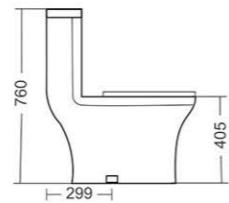

Pure without
any interruptions





An elegant
voyage



3L 3 LITER
FLUSHING

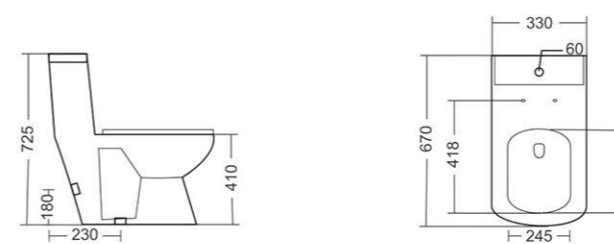

2010

ONE PIECE CLOSET
WASH DOWN FLUSHING
3 LITER FLUSHING

S-TRAP WALL DIST. 225MM

L670, W330, H725MM



2011

ONE PIECE CLOSET
WASH DOWN FLUSHING
3 LITER FLUSHING

S-TRAP WALL DIST. 225MM

L655, W350, H740MM

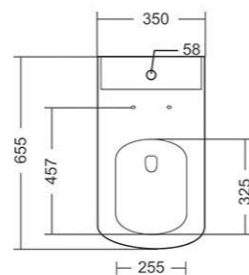
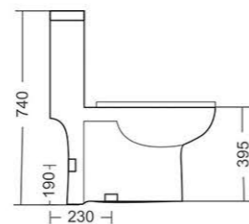

Create embellished
bath spaces

3L 3 LITER
FLUSHING





Mixture of
beauty and emotion



 SIPHONIC

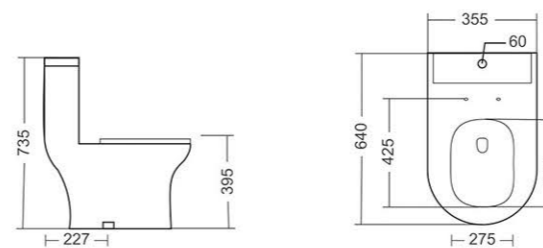

2012

ONE PIECE CLOSET
SIPHONIC FLUSHING

S-TRAP WALL DIST. 225MM / 300MM

L640, W355, H735MM



2013

ONE PIECE CLOSET
SIPHONIC FLUSHING
4D TECHNOLOGY

S-TRAP DIST. 225MM / 300MM

L645, W353, H740MM

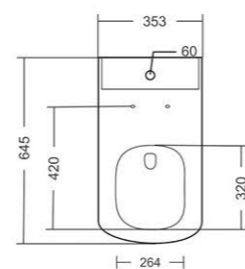
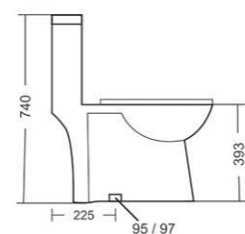

The mark of
marvelous





Timeless symbol
of elegance



 SIPHONIC  4D TECHNOLOGY

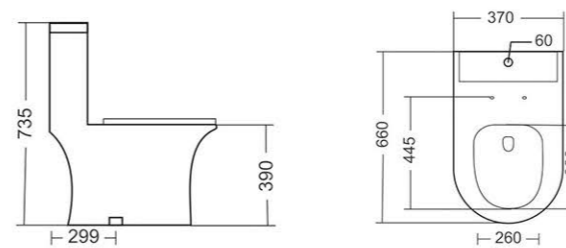

2014

ONE PIECE CLOSET
SIPHONIC FLUSHING
4D TECHNOLOGY

S-TRAP-225MM / 300MM

L660, W370, H735MM

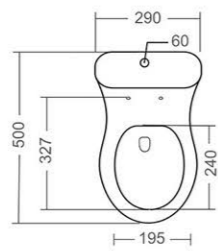
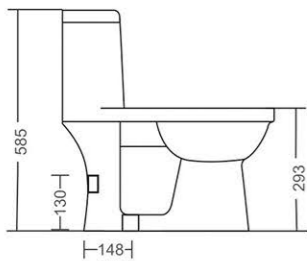

BABY

ONE PIECE CLOSET
WASH DOWN FLUSHING

S-TRAP WALL DIST. 225MM / 300MM

L500, W290, H585MM

P R E M I U M
S A N I T A R Y W A R E



GLOSSINESS AND
WHITENESS

THE PRODUCT ATTRIBUTES



Resistant to limestone,
to impact and to abrasion



The integrated process
of enamel firing ensures
greater durability of
the surfaces over time



Easy and quick cleaning



Scratches & Breaks Easily
Renewable



Each product radiates
glossiness and whiteness



Water-saving flushing
system with 7/4-litre knobs



Soft closing seat cover

**wall hung
closet**





Simplicity in every
gesture



7 RIMLESS

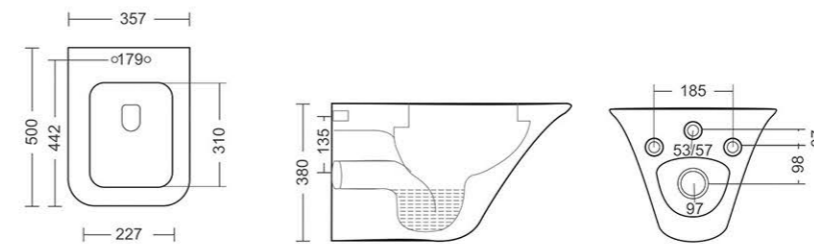

ASPIRE

WALL HUNG CLOSET
RIMLESS

L500, W357, H380MM



COSMOS

WALL HUNG CLOSET
RIMLESS

L490, W360, H360MM

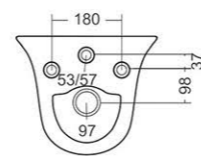
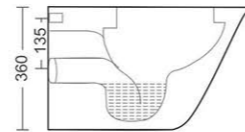
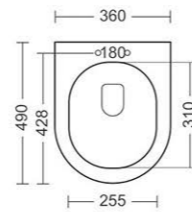

Pleasure of all
the smoothness

7 RIMLESS





Finest and unique design

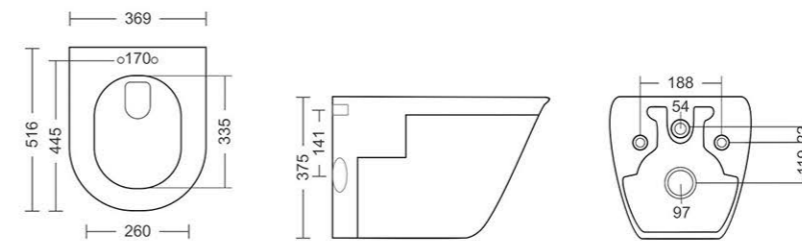

APOLLO

WALL HUNG CLOSET
WASH DOWN FLUSHING

L516, W369, H375MM

Keep smooth and
splendor



CAMRI

WALL HUNG CLOSET
WASH DOWN FLUSHING

L525, W370, H357MM

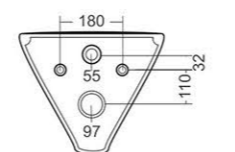
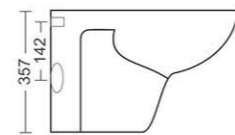
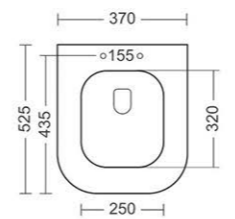



Modern way of living



7 RIMLESS

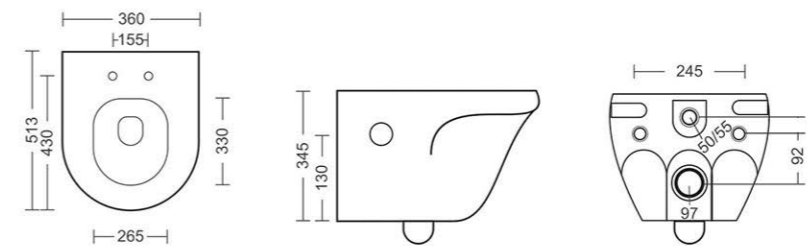

DELTA
WALL HUNG CLOSET
RIMLESS
L513, W360, H345MM



Taste of
elegant art

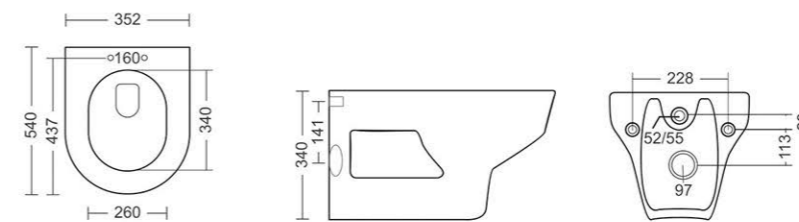

ELLIPS
WALL HUNG CLOSET
WASH DOWN FLUSHING
L540, W352, H340MM



JAZZY

WALL HUNG CLOSET
WASH DOWN FLUSHING
(WITH JET / WITHOUT JET)

L467, W363, H385MM

Adds modern
touch

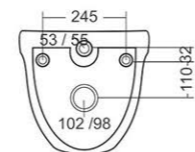
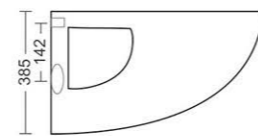
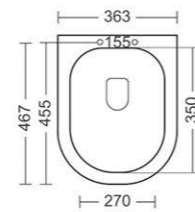



Embrace simple
beauty

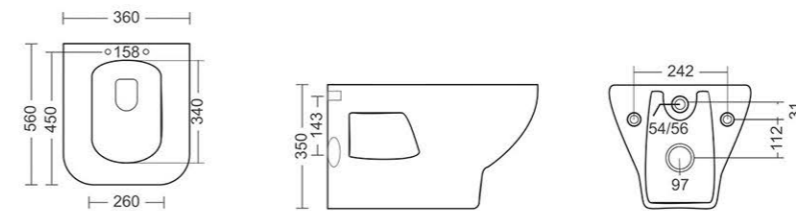

KALLIS
WALL HUNG CLOSET
WASH DOWN FLUSHING
L560, W360, H350MM

The charisma of
simplicity



LUMINIA

WALL HUNG CLOSET
WASH DOWN FLUSHING

L480, W345, H326MM

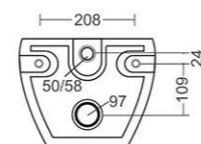
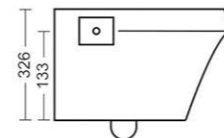
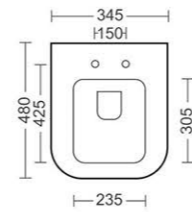



Reflection of your
personality

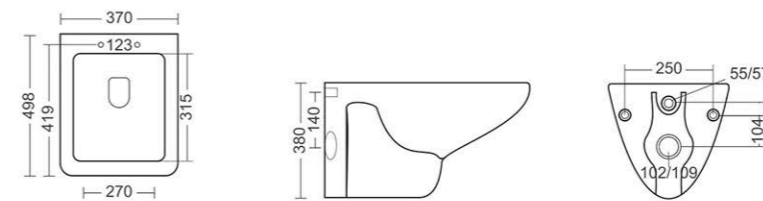

MINI-NEPTA

WALL HUNG CLOSET
WASH DOWN FLUSHING

L498, W370, H380MM

The ideal elegant
elements



NEPTA

WALL HUNG CLOSET
WASH DOWN FLUSHING

L545, W350, H375MM

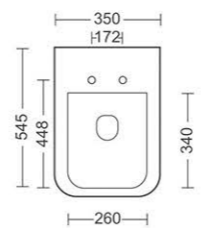
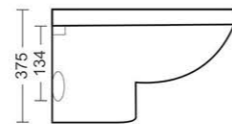
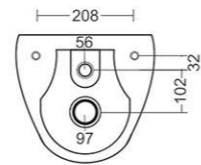



Symbol of
elegance



7 RIMLESS

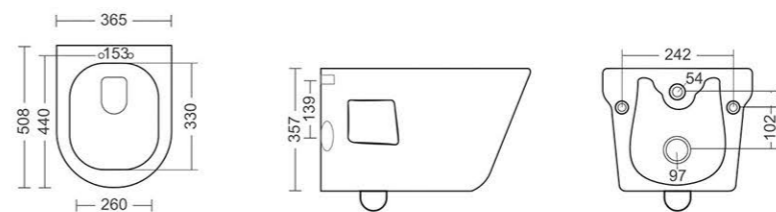

RIGA

WALL HUNG CLOSET
RIMLESS

L508, W365, H357MM



ROSSA

WALL HUNG CLOSET
RIMLESS

L528, W355, H359MM

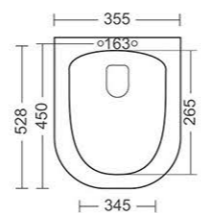
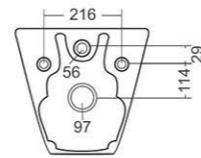

Get the absolute
style

7 RIMLESS





Reflection of
unmatched
brilliance

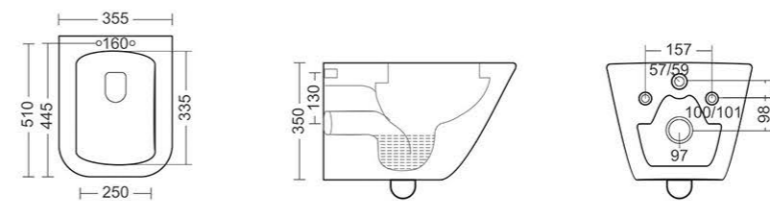

RUBIC
WALL HUNG CLOSET
WASH DOWN FLUSHING
L510, W355, H350MM

Crafted
to perfection



SNAZZY

WALL HUNG CLOSET
WASH DOWN FLUSHING

L468, W367, H375MM

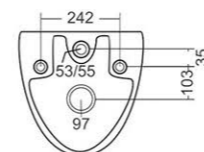
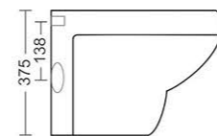
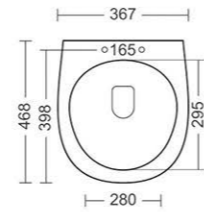



Defined by
lavish design



- 7 RIMLESS
- TORNADO FLUSHING
- 4D TECHNOLOGY

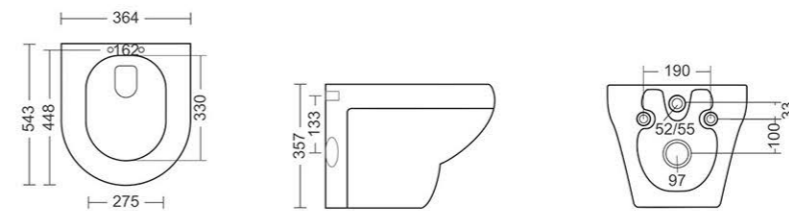

SPENTA

WALL HUNG CLOSET
RIMLESS
TORNADO FLUSHING
4D TECHNOLOGY

L543, W364, H357MM

Enriches
the bath space



STAR

WALL HUNG CLOSET
WASH DOWN FLUSHING

L498, W375, H373MM

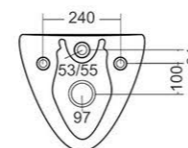
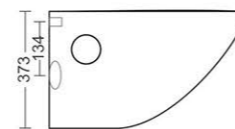
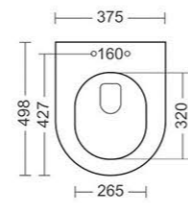



Keep
you in charm



7 RIMLESS

TORNADO FLUSHING

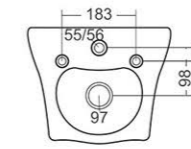
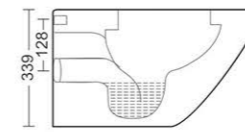
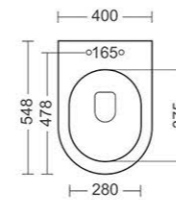

TITA

WALL HUNG CLOSET
RIMLESS
TORNADO FLUSHING

L548, W400, H339MM

Connects
you with arts



VENICE

WALL HUNG CLOSET
WASH DOWN FLUSHING

L515, W370, H357MM

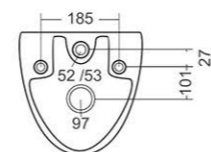
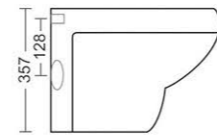
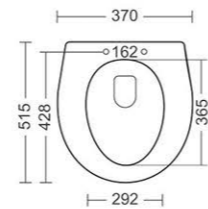



Bring the
Tranquil and
freshness

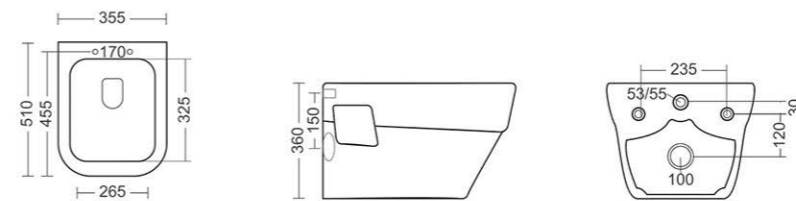

VISTA
WALL HUNG CLOSET
WASH DOWN FLUSHING
L503, W350, H350MM

An exclusive
and refined look



ZETA

WALL HUNG CLOSET
RIMLESS
TORNADO FLUSHING

L505, W375, H335MM

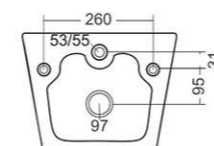
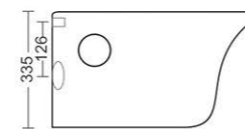
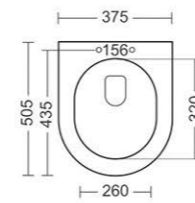

A natural
finish of arts



CRETA 2 PIECE

WALL HUNG CLOSET
WASH DOWN FLUSHING

L658, W383, H772MM

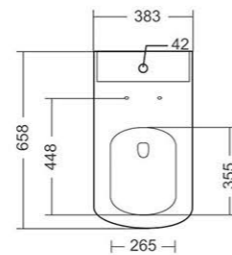
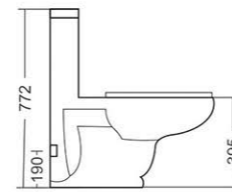



**table top
basin**





ALTO

TABLE TOP BASIN
5MM THINNEST
L277, W277, H116MM

→ | ← 5MM
THINNEST

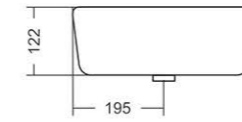
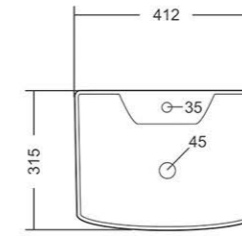
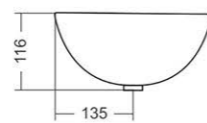
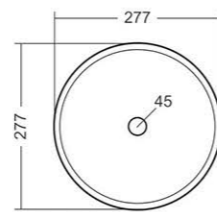

AMY

TABLE TOP BASIN
5MM THINNEST
L315, W412, H122MM

→ | ← 5MM
THINNEST





ARIZON

TABLE TOP BASIN
L302, W523, H129MM

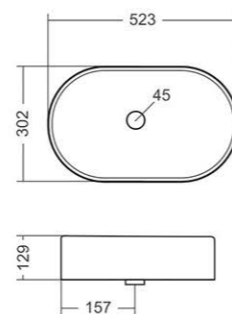

ARTIZ

TABLE TOP BASIN
5MM THINNEST
L435, W719, H129MM



→ ← 5MM
THINNEST

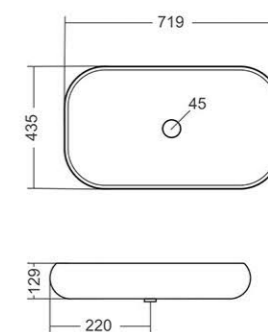



CADIZ

TABLE TOP BASIN
L343, W430, H179MM

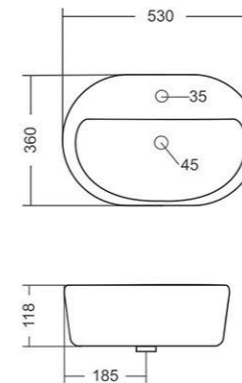
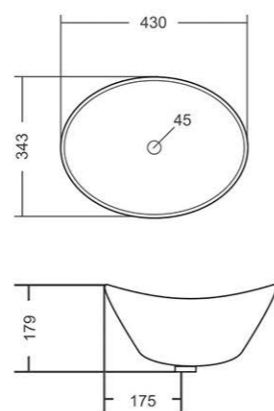

COCO

TABLE TOP BASIN
5MM THINNESS

L360, W530, H118MM

→ ← 5MM THINNESS





COMPACT

TABLE TOP BASIN
5MM THINNEST

L398, W398, H140MM



→ 5MM THINNEST ←

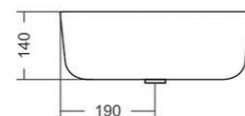
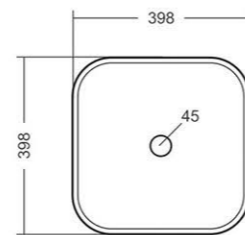

CONCA

TABLE TOP BASIN
L506, W410, H160MM

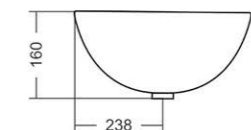
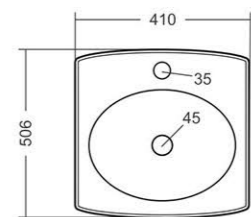



CORAL

TABLE TOP BASIN
5MM THINNEST
L432, W432, H129MM



→ ← 5MM
THINNEST

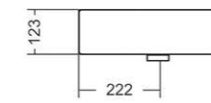
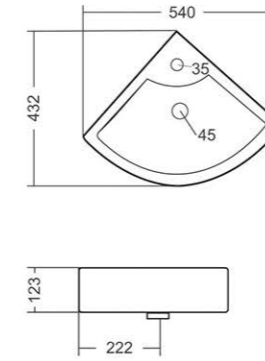
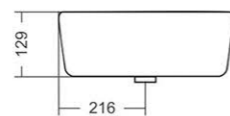
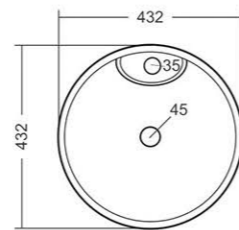

CORUS

TABLE TOP BASIN
L432, W540, H123MM





CROMA

TABLE TOP BASIN
L446, W160, H400MM

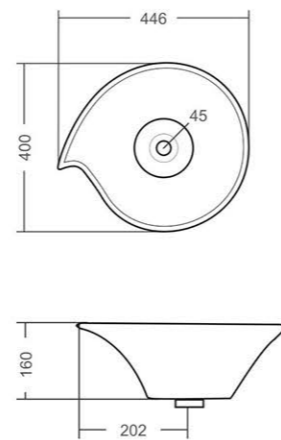

CRUSE

TABLE TOP BASIN
L377, W688, H147MM

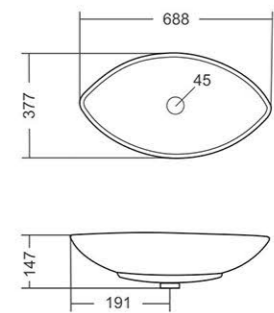



CRYSTAL

TABLE TOP BASIN
5MM THINNEST
L407, W505, H145MM

→ ← 5MM
THINNEST

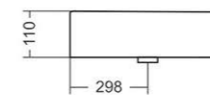
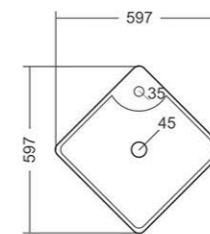
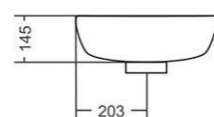
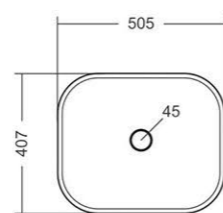

CUBE

TABLE TOP BASIN
5MM THINNEST
L597, W597, H110MM

→ ← 5MM
THINNEST





ERA

TABLE TOP BASIN
L427, W427, H173MM

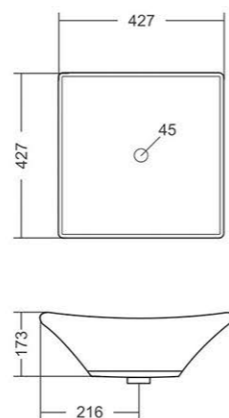

FLORA

TABLE TOP BASIN
5MM THINNEST
L375, W662, H145MM



→ ← 5MM
THINNEST

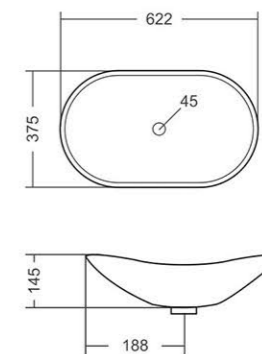



GEO

TABLE TOP BASIN
L360, W368, H151MM

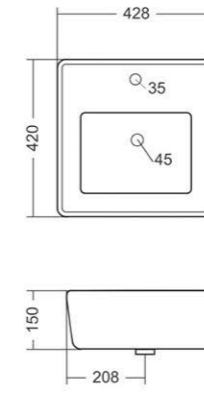
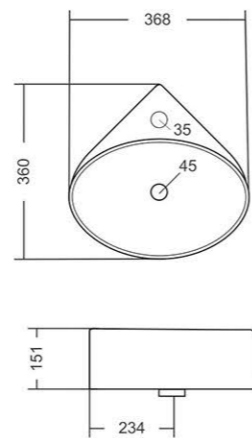

INOX

TABLE TOP BASIN
L420, W428, H150MM





IRIS

TABLE TOP BASIN
5MM THINNEST

L458, W458, H176MM



→ 5MM THINNEST ←

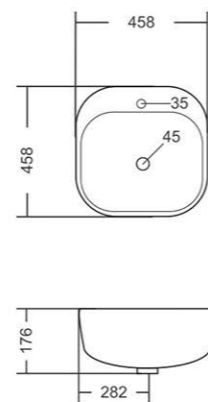

ISVEA

TABLE TOP BASIN
5MM THINNEST

L375, W468, H132MM



→ 5MM THINNEST ←

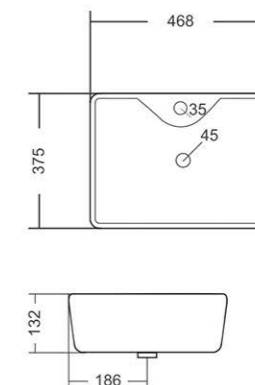



LEO

TABLE TOP BASIN
5MM THINNEST

L383, W544, H165MM



5MM
THINNEST

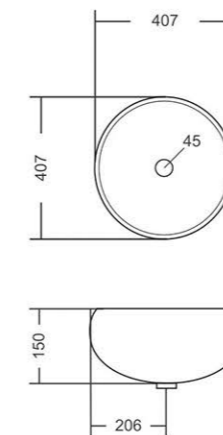
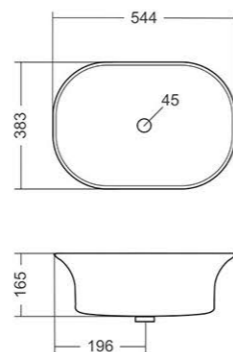

LEWIS

TABLE TOP BASIN
L407, W407, H150MM





LINIA

TABLE TOP BASIN
5MM THINNEST

L395, W580, H142MM



→ 5MM THINNEST ←

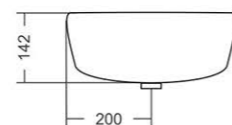
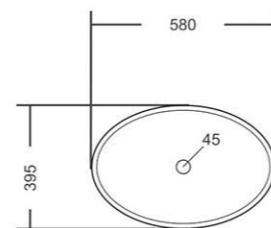

MARCO

TABLE TOP BASIN
5MM THINNEST

L405, W405, H115MM



→ 5MM THINNEST ←

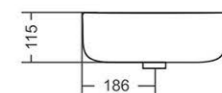
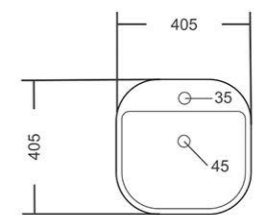



METRO

TABLE TOP BASIN
5MM THINNEST
L540, W380, H126MM

→ ← 5MM
THINNEST

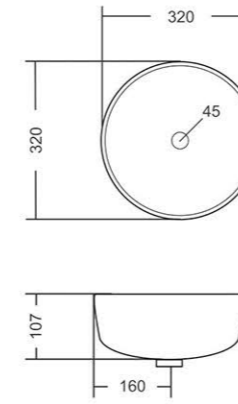
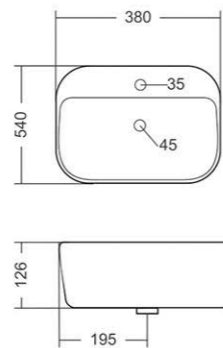

NEXA

TABLE TOP BASIN
5MM THINNEST
L320, W320, H107MM

→ ← 5MM
THINNEST





NEXUS

TABLE TOP BASIN
L360, W470, H124MM

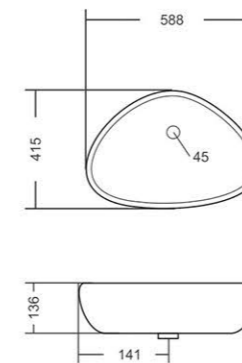
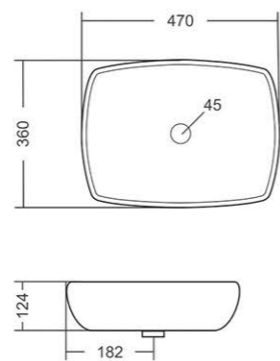

PRIMA

TABLE TOP BASIN
5MM THINNESS

L415, W588, H136MM

→ ← 5MM
THINNESS





PRISTINE

TABLE TOP BASIN
L413, W570, H125MM

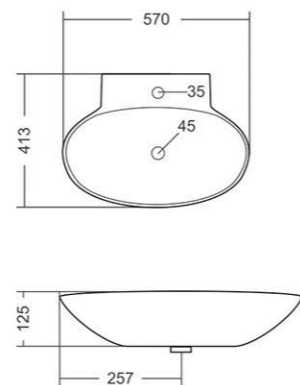

RADO

TABLE TOP BASIN
L437, W432, H116MM

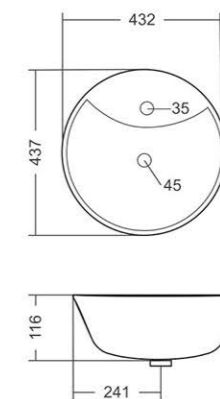



RIPON

TABLE TOP BASIN
L391, W527, H125MM

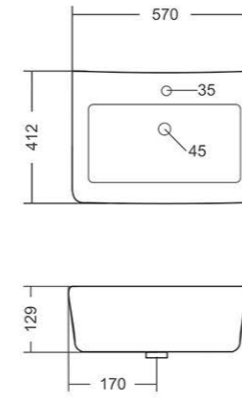

SAI

TABLE TOP BASIN
L412, W570, H129MM

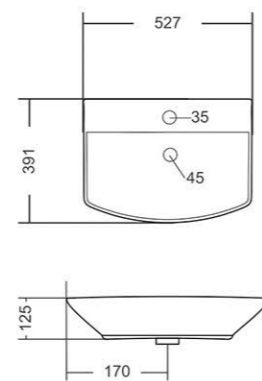



SLIK

TABLE TOP BASIN
L373, W373, H138MM

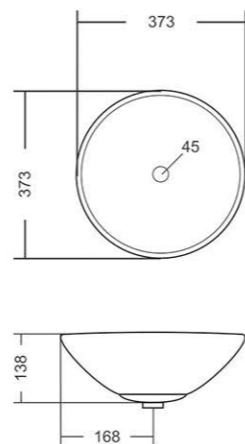

SLOG

TABLE TOP BASIN
L410, W410, H126MM

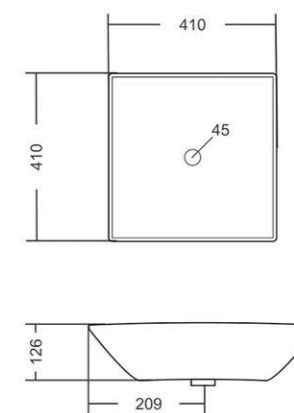



SOAR

TABLE TOP BASIN
L355, W456, H136MM

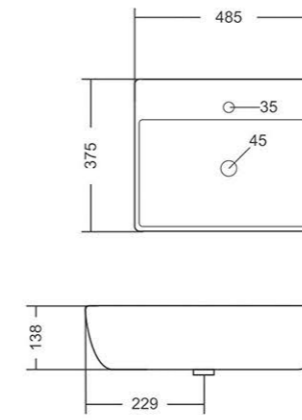

SOBER

TABLE TOP BASIN
L375, W485, H138MM

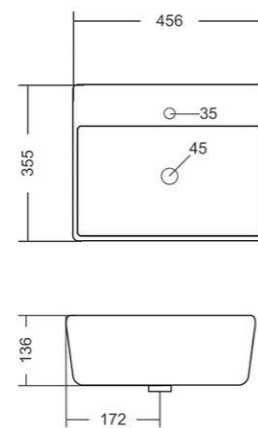



STAR

TABLE TOP BASIN
L375, W375, H121MM

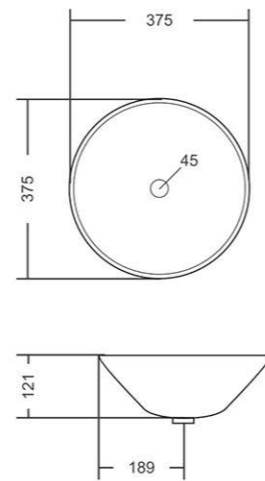

SUN

TABLE TOP BASIN
L395, W395, H157MM

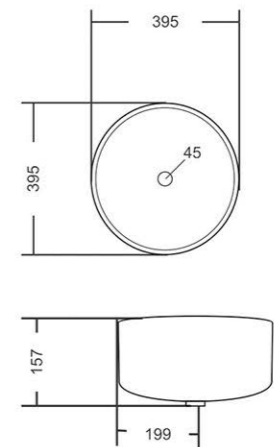



SYMON

TABLE TOP BASIN
L420, W413, H127MM

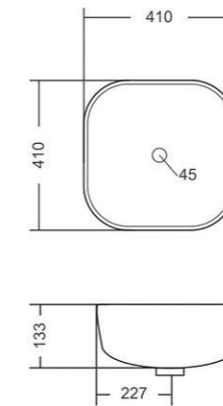
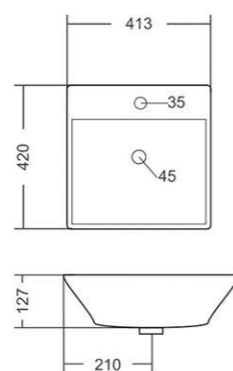

TERRA

TABLE TOP BASIN
L410, W410, H133MM





VIVA

TABLE TOP BASIN
5MM THINNEST

L435, W435, H137MM



→ 5MM THINNEST ←

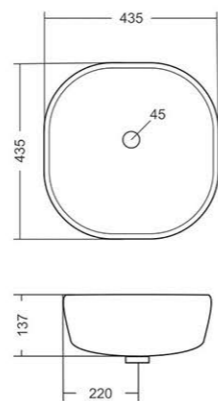

XOLO

TABLE TOP BASIN
5MM THINNEST

L300, W300, H130MM



→ 5MM THINNEST ←

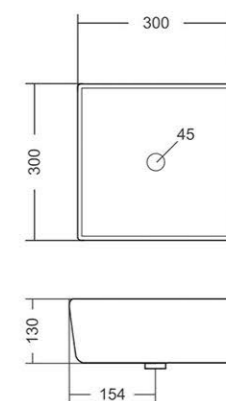



wash basin



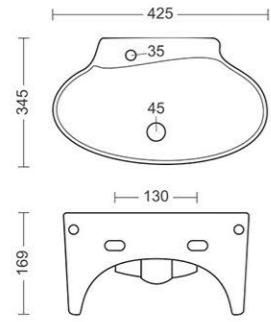

APPLE

WASH BASIN
L345, W425, H169MM

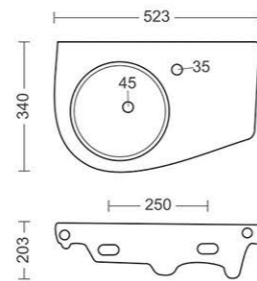

BRUNO

WASH BASIN
L340, W525, H203MM

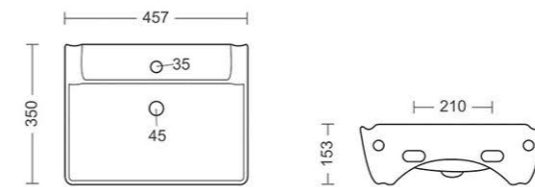

CANVAS

WASH BASIN
L350, W457, H153MM

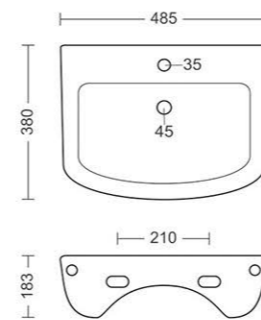

CHICAGO

WASH BASIN
L380, W485, H183MM

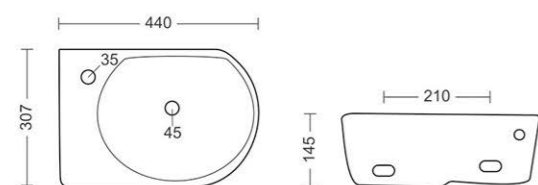

CASSIO

WASH BASIN
L307, W440, H145MM



CLASSIC

WASH BASIN
L360, W460, H200MM

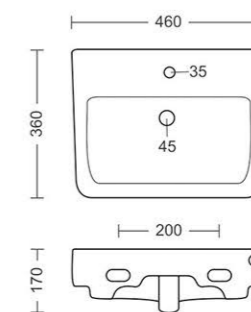

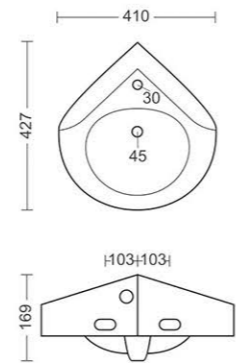

CORNER

WASH BASIN
L427, W410, H169MM

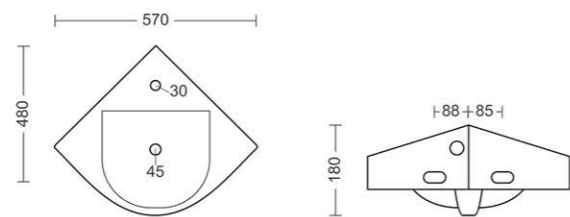

COZY

WASH BASIN
L480, W570, H180MM

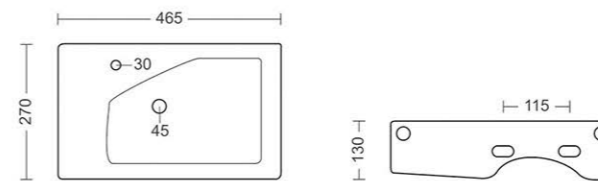

ESTILO

WASH BASIN
L270, W465, H130MM



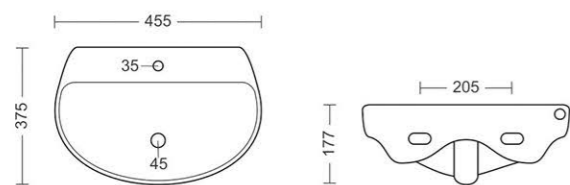

Eva
WASH BASIN
L375, W455, H177MM

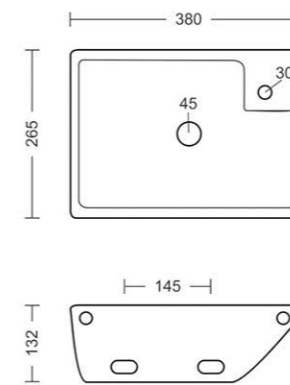

FIERO
WASH BASIN
L265, W380, H132MM

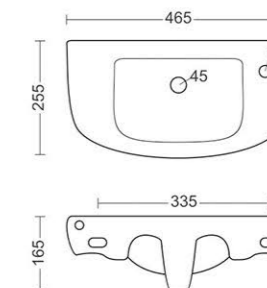

FLAIRE
WASH BASIN
L265, W465, H165MM

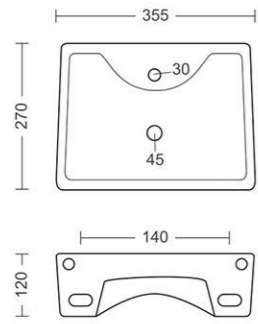

GEM

WASH BASIN
L270, W355, H120MM

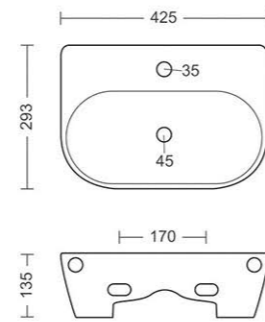

LEXO

WASH BASIN
L293, W425, H135MM

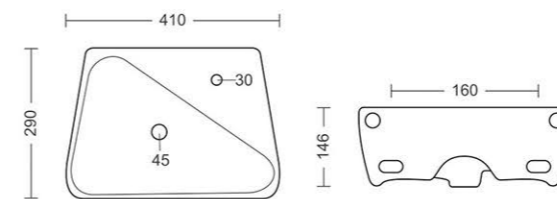

LILY

WASH BASIN
L290, W410, H146MM

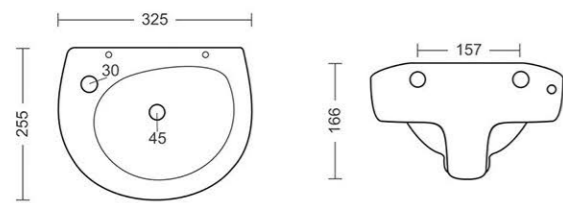

MANGO

WASH BASIN
L255, W325, H166MM

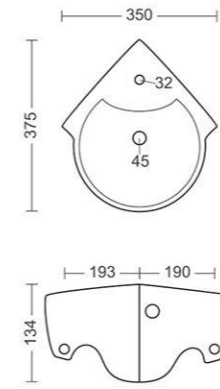

MINI CORNER

WASH BASIN
L375, W350, H134MM



MINI SYNDICATE

WASH BASIN
L325, W285, H130MM

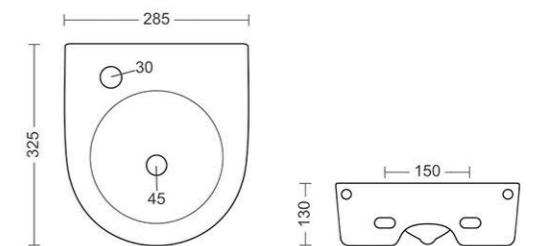

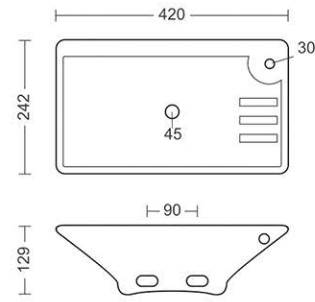

PARITY

WASH BASIN
L242, W420, H129MM

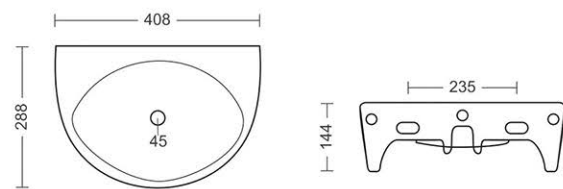

PEARL

WASH BASIN
L288, W408, H144MM

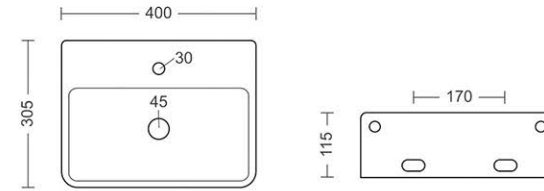

PLAZMA

WASH BASIN
L305, W400, H170MM



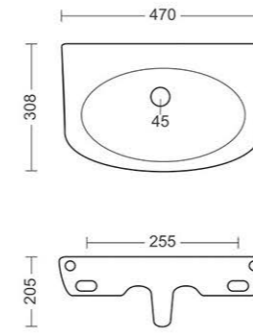

SIPRA

WASH BASIN
L308, W470, H205MM

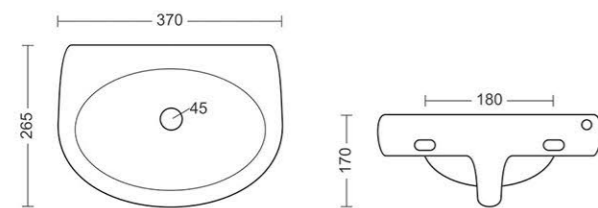

SHALLY

WASH BASIN
L265, W370, H170MM

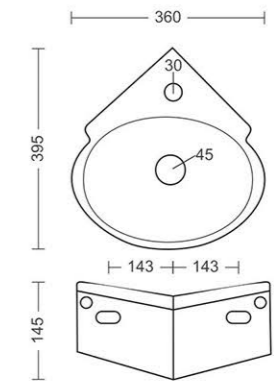

SKIM

WASH BASIN
L395, W360, H145MM

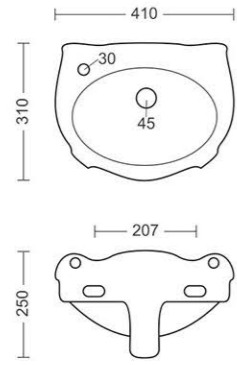

SMILE

WASH BASIN
L310, W410, H250MM

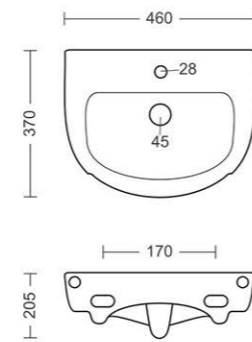

SPOUSE

WASH BASIN
L370, W460, H170MM

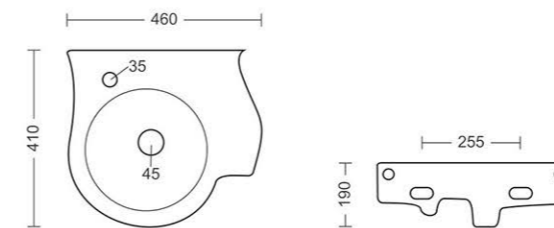

STYLO

WASH BASIN
L410, W460, H190MM

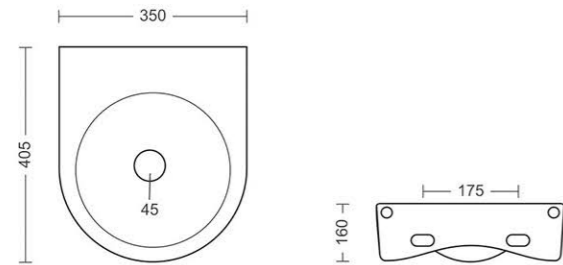

SYNDICATE

WASH BASIN
L405, W350, H160MM

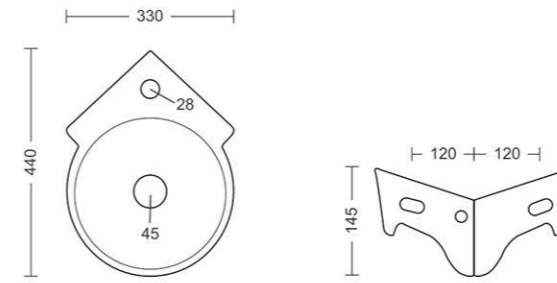

TIM

WASH BASIN
L440, W330, H145MM





one piece basin





ADOR

ONE PIECE BASIN
L440, W500, H365MM

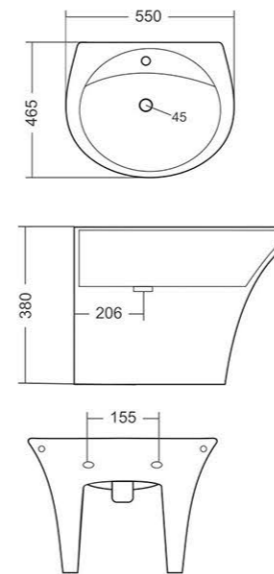

ALFA

ONE PIECE BASIN
L465, W550, H380MM

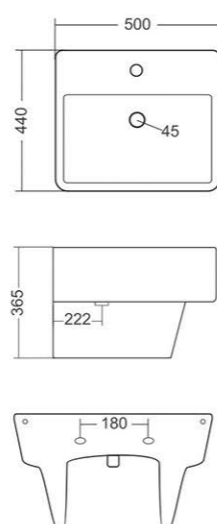



BIG PETAL

ONE PIECE BASIN
L440, W460, H327MM

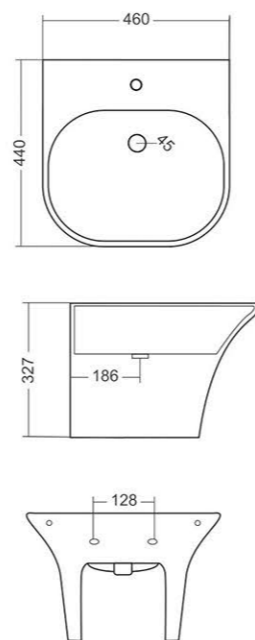

OMEGA

ONE PIECE BASIN
L370, W370, H225MM

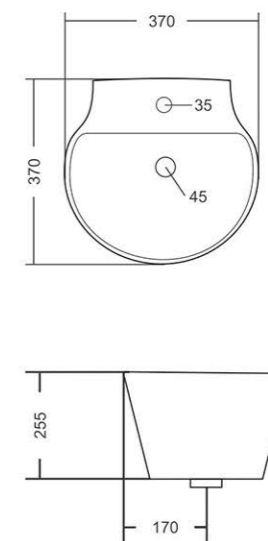



PETAL

ONE PIECE BASIN
L370, W340, H280MM

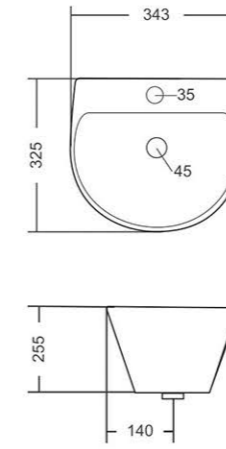

POLO

ONE PIECE BASIN
L325, W343, H255MM

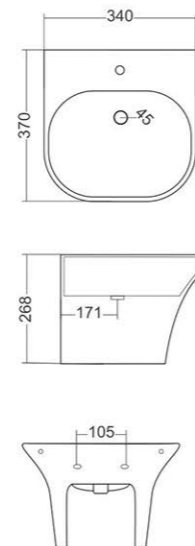



SYSCO

ONE PIECE BASIN
L445, W435, H340MM

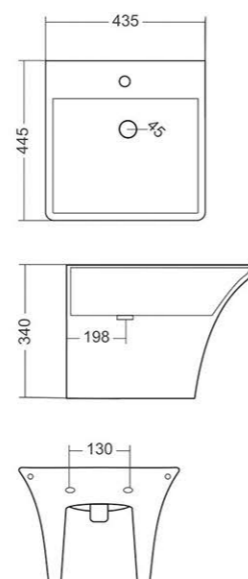

PREMIUM SANITARYWARE



WATER SLIDES FAST
ON THE SURFACE

THE PRODUCT ATTRIBUTES



Water-repellent: water slides fast on the surface



The surface is perfectly smooth



Easy and quick cleaning



Greater surface brilliance



Environmental Sustainability
reduced water consumption and cleaning detergents



High resistance to external agents,
longer durability.



**half & full
pedestal**





FULL PEDESTAL
L460, W570, H850MM

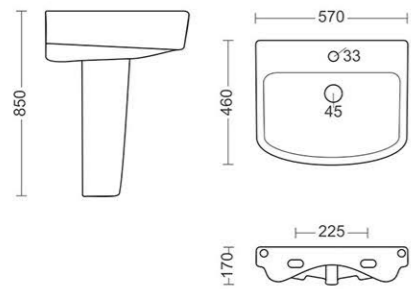

ALTIS



HALF PEDESTAL
L460, W568, H516MM

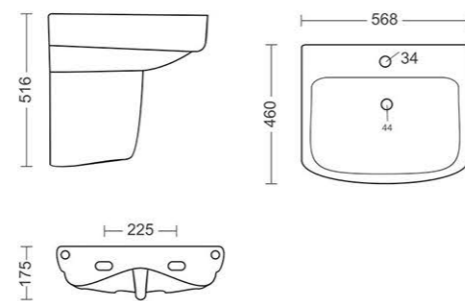

CORINA

FULL PEDESTAL
L465, W765, H900MM

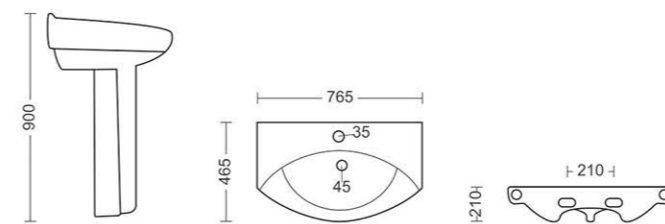

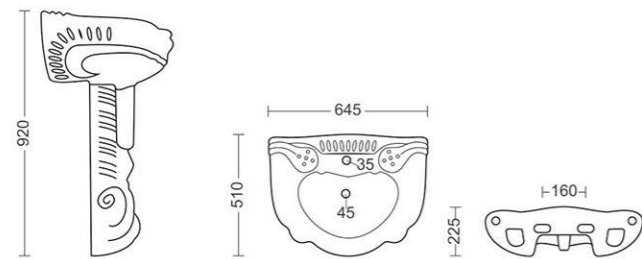

MAJESTY

FULL PEDESTAL
L510, W645, H920MM

FULL PEDESTAL
L420, W530, H870MM

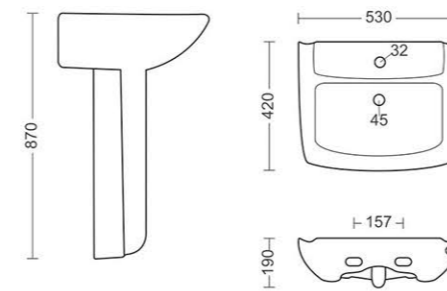

LOURET

HALF PEDESTAL
L425, W520, H505MM

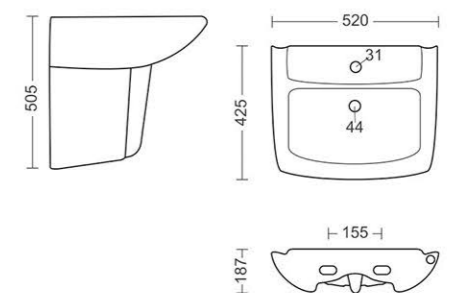



FULL PEDESTAL
L422, W560, H850MM

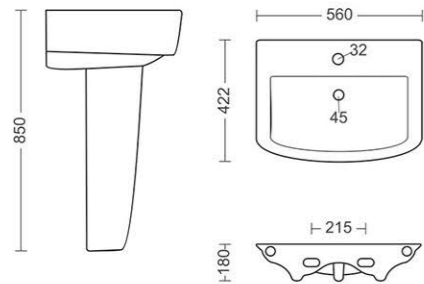

NEO



HALF PEDESTAL
L430, W555, H505MM

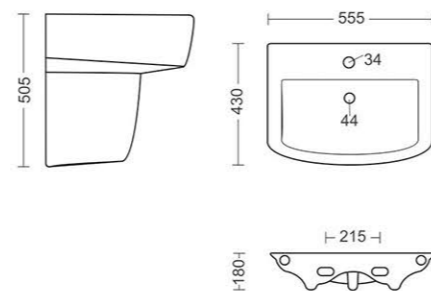

NOVA

HALF PEDESTAL
L440, W510, H521MM

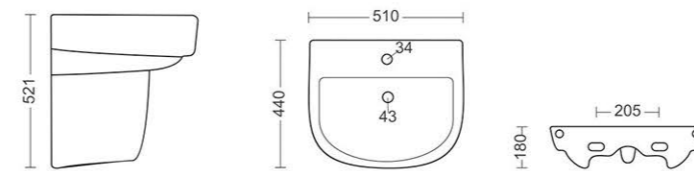

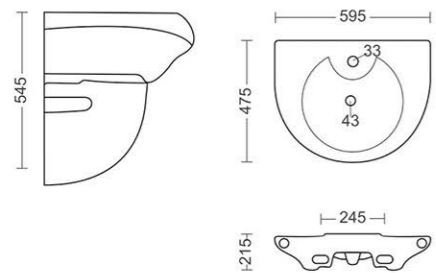

HALF PEDESTAL
L475, W595, H545MM

OLIVE

FULL PEDESTAL
L475, W595, H880MM

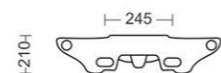
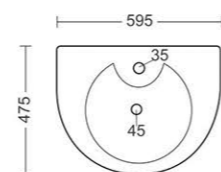
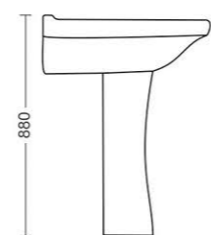

FULL PEDESTAL
L465, W585, H875MM

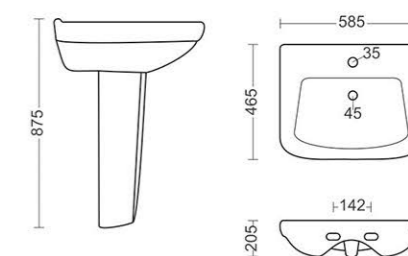

PARISH

HALF PEDESTAL
L360, W650, H720MM

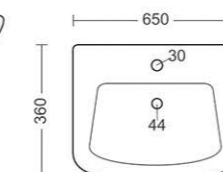
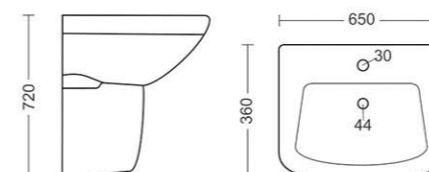

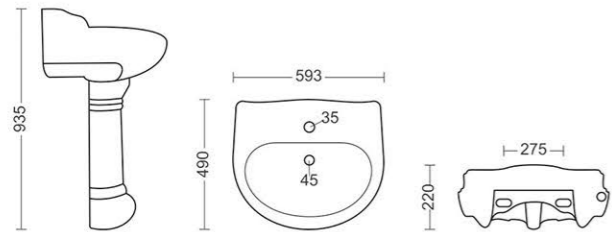

SERENA

FULL PEDESTAL
L490, W593, H935MM

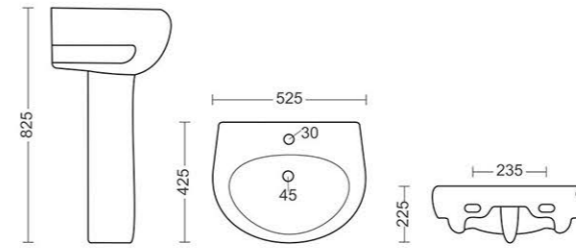

SAMITE

FULL PEDESTAL
L425, W525, H825MM





FULL PEDESTAL
L435, W570, H880MM

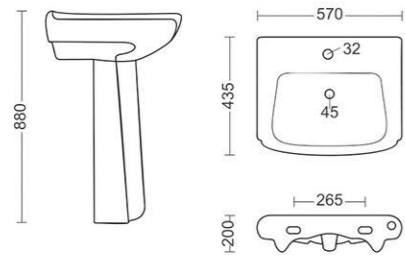

SOPHIA



HALF PEDESTAL
L425, W560, H513MM

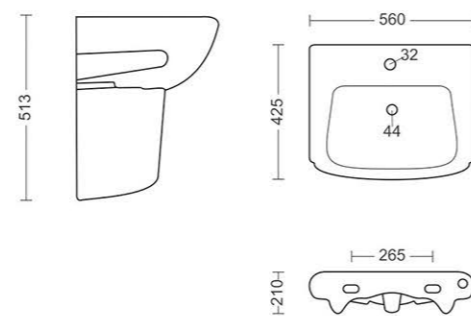

STEPHY

FULL PEDESTAL
L430, W590, H815MM

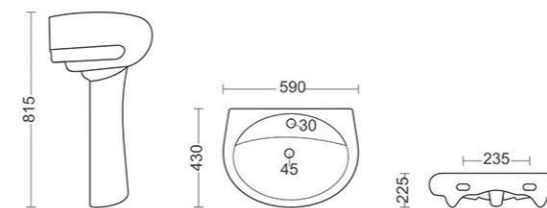

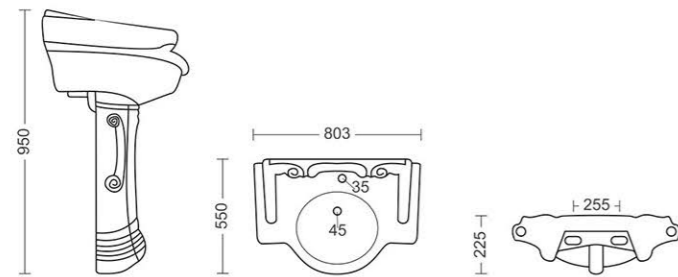

STERLING ROYA

FULL PEDESTAL
L550, W803, H950MM

STERLING

FULL PEDESTAL
L510, W645, H970MM



SCOOTY

HALF PEDESTAL
L365, W480, H510MM

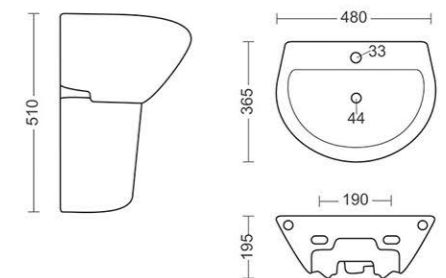



FULL PEDESTAL
L455, W580, H845MM

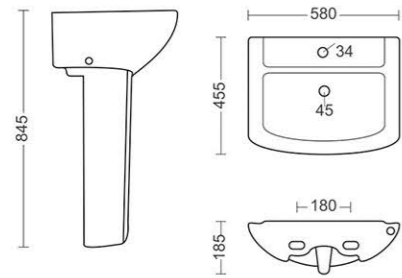

VENICE



HALF PEDESTAL
L455, W580, H545MM

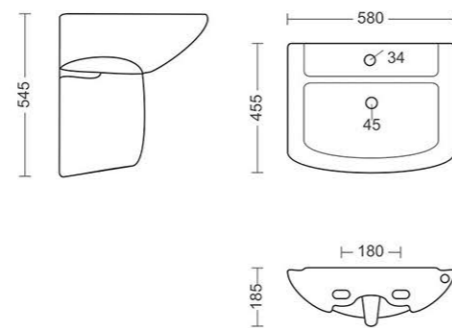

SUPREME

FULL PEDESTAL
L490, W595, H870MM

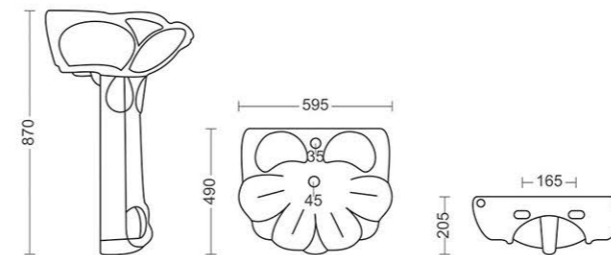

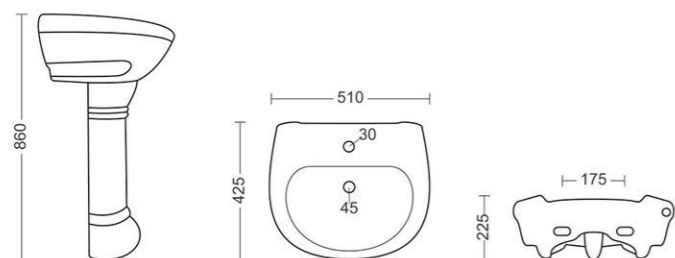

SWING
FULL PEDESTAL
L425, W510, H860MM

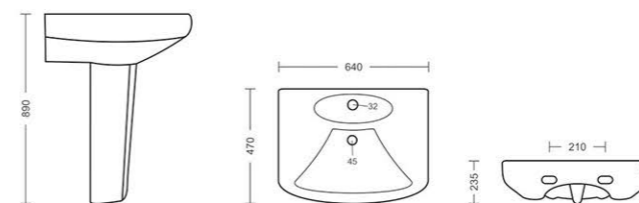

VEGA
FULL PEDESTAL
L470, W640, H890MM



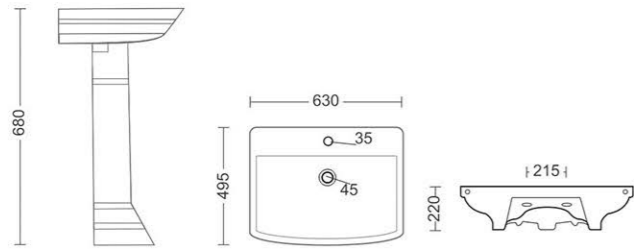

LARA
FULL PEDESTAL
L620, W490, H800MM

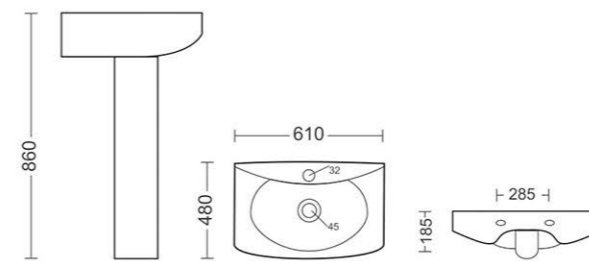

RETRO
FULL PEDESTAL
L610, W475, H863MM



under counter basin



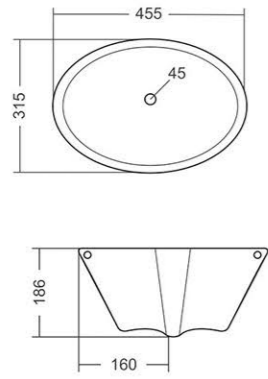

ASTA

UNDER COUNTER BASIN
L315, W455, H186MM

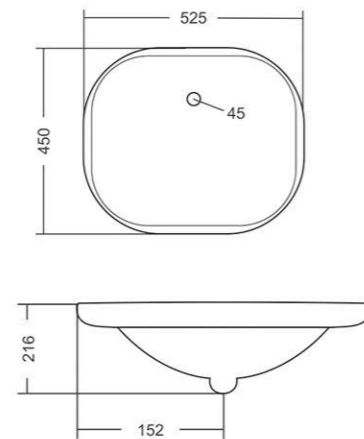

GARNET

UNDER COUNTER BASIN
L450, W525, H216MM

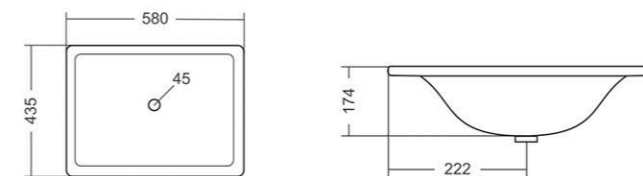

LATINA

UNDER COUNTER BASIN
L435, W580, H174MM

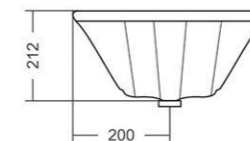
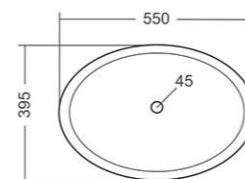

SPINZ
UNDER COUNTER BASIN
L395, W550, H212MM

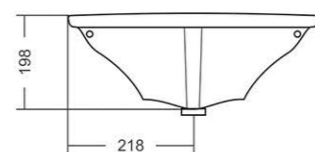
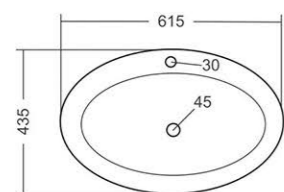

LOMANI
UNDER COUNTER BASIN
L435, W615, H198MM



floor mount Ewc

water closet
& orrisa pan



Experience the
modern craft



GRACE

FLOOR MOUNT EWC
WASH DOWN

L545, W350, H410MM

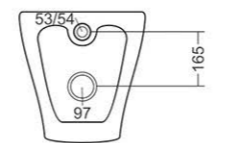
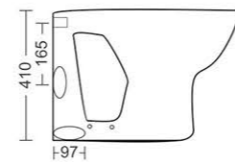
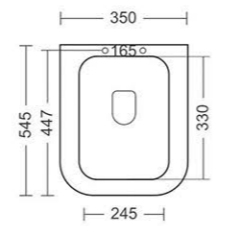

Blending into
elegant style



SOFEN

FLOOR MOUNT EWC
WASH DOWN

L530, W350, H397MM

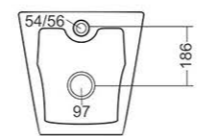
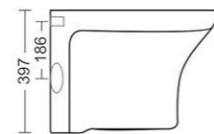
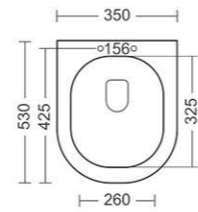



Turn into
gorgeous looks

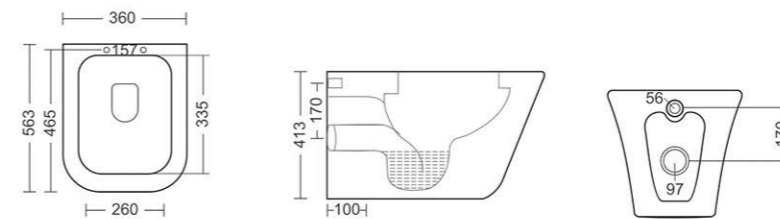

RECTO

FLOOR MOUNT EWC
WASH DOWN

L563, W360, H413MM

Reflecting the
modern lifestyle



DIAMOND

FLOOR MOUNT EWC
WASH DOWN

L565, W350, H420MM

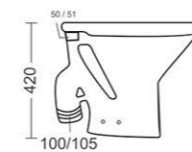
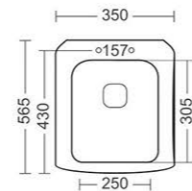

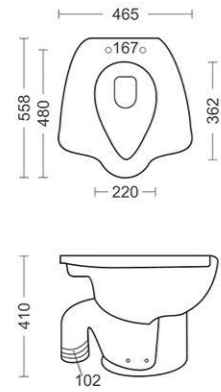

ANGLO

WATER CLOSET
L558, W465, H410MM



SELVO

WATER CLOSET
L545, W465, H405MM

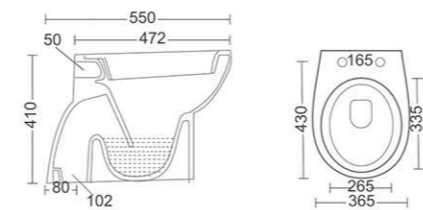

SPICE

WATER CLOSET
L430, W550, H410MM

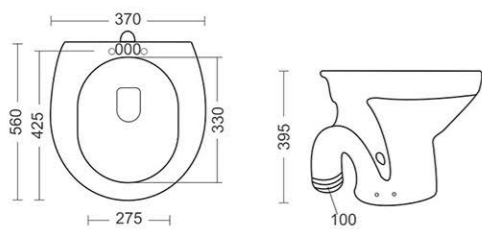

STEPHY

WATER CLOSET
L560, W370, H395MM

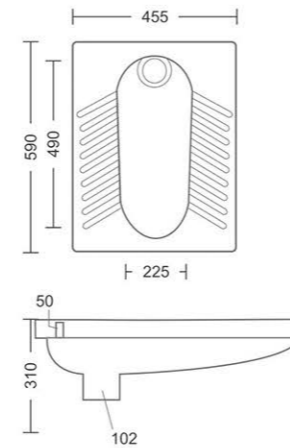

23" ORISSA

ORRISA PAN
L590, W455, H310MM

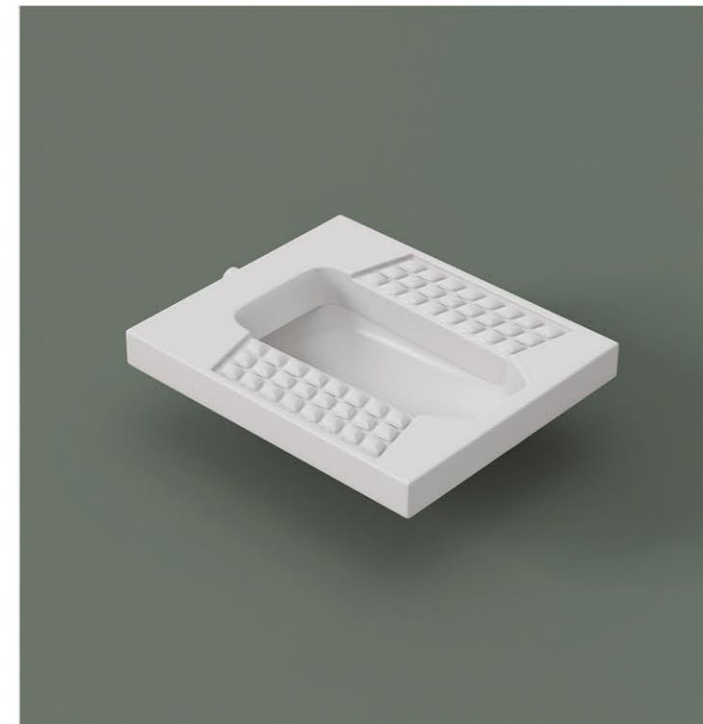

AQU PAN

ORRISA PAN
L580, W445, H290MM

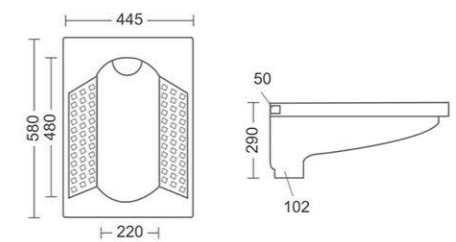

O.P. 20"

ORRISA PAN
L515, W410, H180MM

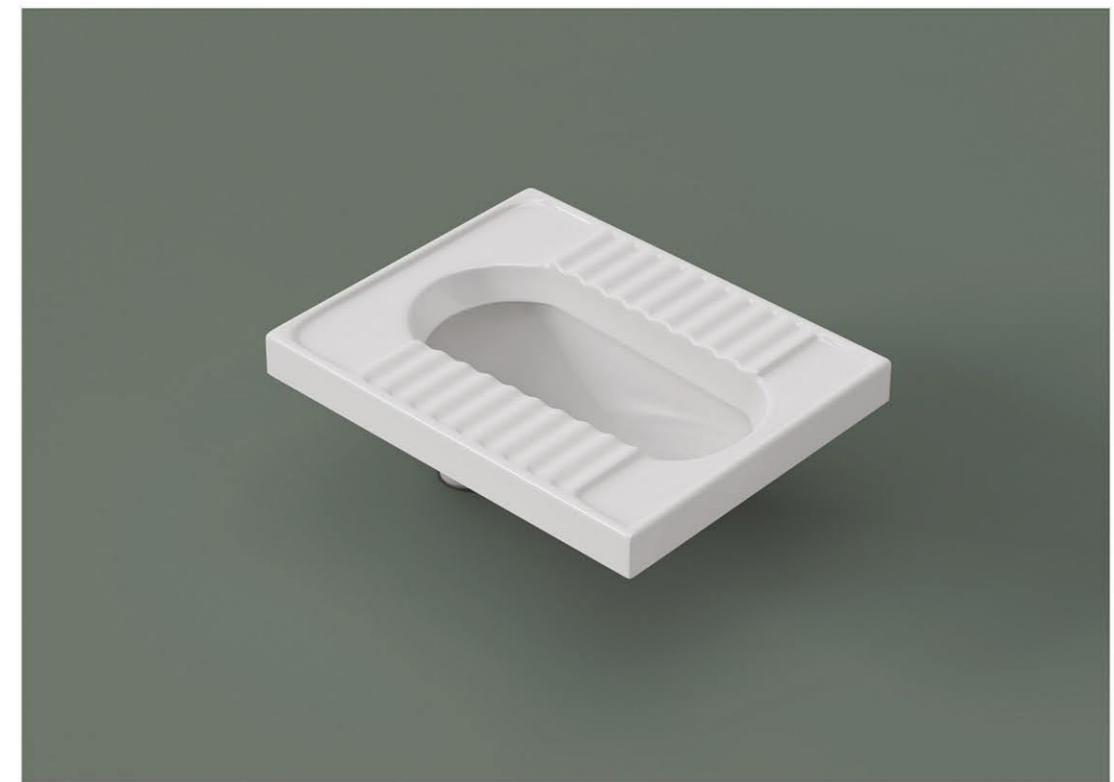
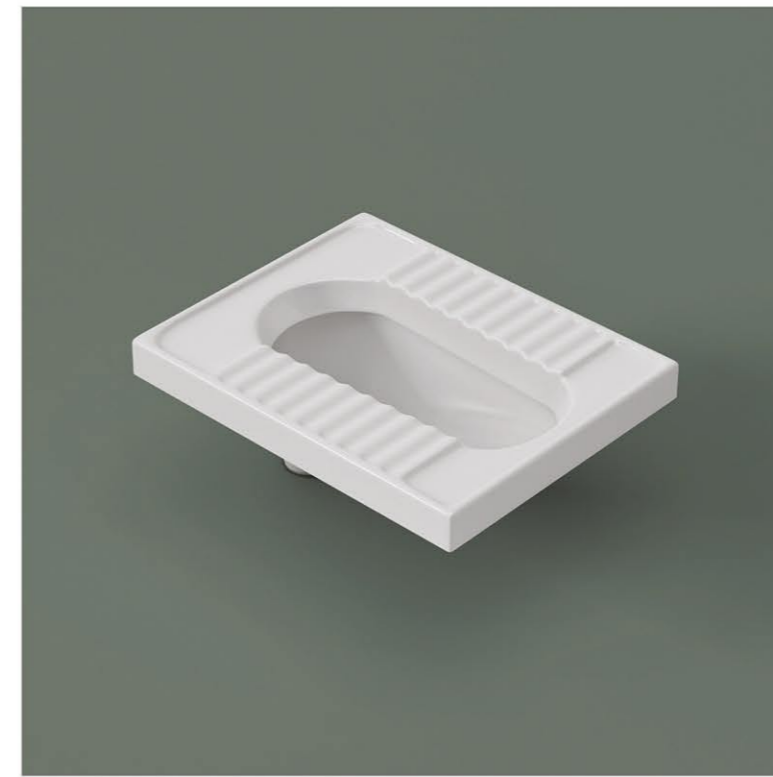
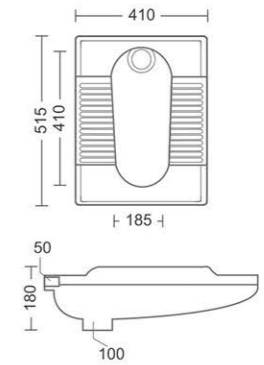

O.P. 23"

ORRISA PAN
L590, W455, H310MM

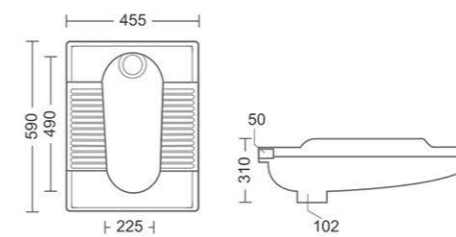

**ARAB PAN
(CT PAN)**

ORRISA PAN
L535, W452, H185MM

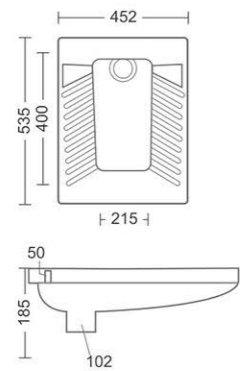

HEALTH ORISSA

ORRISA PAN
L590, W455, H310MM

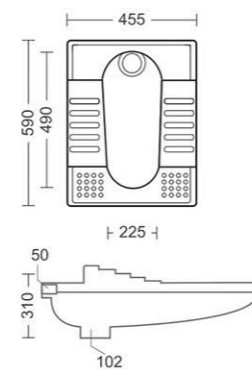



urinal

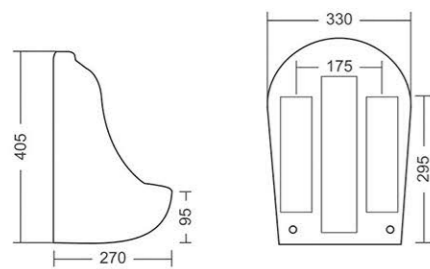

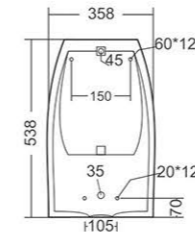
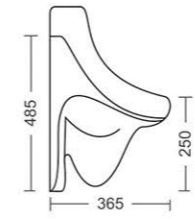

ALDO
URINAL
L270, W330, H405MM



BRONZA
URINAL
L365, W358, H538MM



DIVISIONAL PLATE

URINAL
L95, W327, H675MM

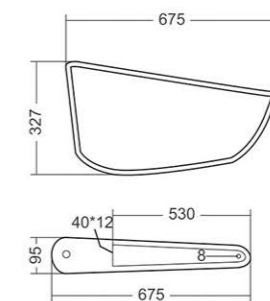

EUREKA

ORRISA PAN
L250, W300, H450MM

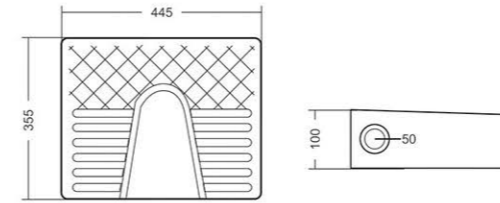
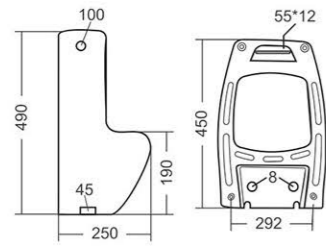

LADIES URINAL

URINAL
L355, W445, H100MM



KITO

ORRISA PAN
L320, W240, H500MM

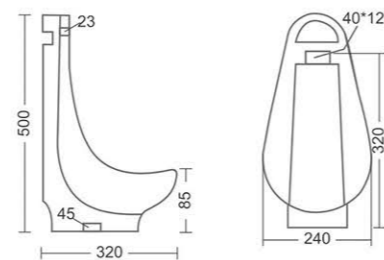

LARGE

URINAL
L375, W400, H595MM

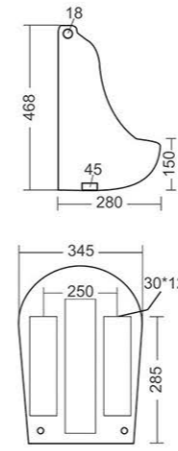
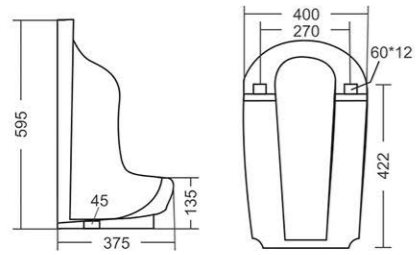

TOVA

URINAL
L280, W345, H468MM



SPARK

URINAL
L310, W320, H515MM

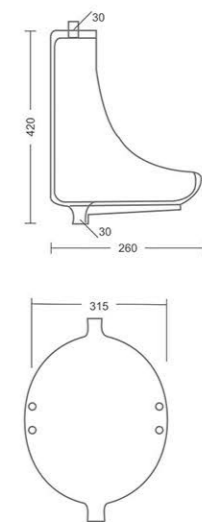
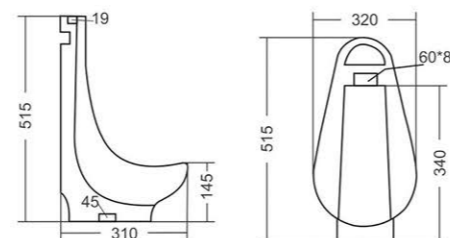

FLAT BACK

URINAL
L260, W315, H420MM

INSTALLATION

MAINTENANCE

A few minutes everyday... and a beautiful bathroom forever. Like any other part of your house, the bathroom can be made to look great and made to last if it is taken care of regularly. Here are some simple tips that can help you keep your bathroom space and span.

Wash Basin

The wash basin needs to be washed with a mild detergent at least once a day. After washing, the basin must be wiped dry to avoid water stains, especially on dark colours.

Closets

Use a plastic bristled brush with a plastic handle to scrub the toilet with a cleanser like Harpic, at least once a day.

After flushing the toilet, give it a "once over" with the brush to avoid minute discoloring.

Keep the toilet brush handy in a convenient stand/ cover nearby.

In the case of Vitreous China Sanitaryware like Silware toilets and basins, if there has been no maintenance over a long period of time, water deposits and discoloration can form on the surface of areas that get wet. In such cases, these stains/ marks can be removed with the help of a solution of dilute hydrochloric acid.

Clean with a soft cloth and warm soapy water.

Use a liquid cleaner at least once a week. Do not use powder paste, thinner or dry cleaning liquids.

To remove fine scratches, use Brasso or car rubbing compound and then polish with a polish cloth.

CONCEALED WALL HUNG

1. If the wall is going to be plastered for a thickness of 12 mm and a tile thickness of 6-7 mm, the projection of the bolts from the finished wall should be 66 mm only.
2. If the thickness of plastering and tile is less than the dimensions mentioned above, the bolts that are supplied along with the bracket should be moved into the wall by using a suitable spacer washer between the bolt head and the bracket frame.
3. The bracket should be buried into the floor so that the height from the center line of the bolt to the surface of the finished floor is 320 mm.

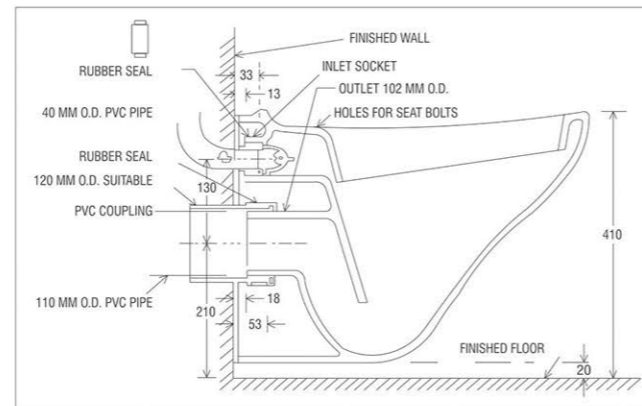

INSTALLATION & MAINTENANCE TIPS

1. Use C.I. Brackets with rag bolts to install Wash Basin with or without pedestal. If Wash Basin is large in size than it is recommended to install on pedestal screwed to the floor.
2. All Wall Mounting E.W.C. to be installed with the help of C.I. Chair bracket as well as with heavy duty rag bolt with cap and rubber bush and outlet coupler.
3. All Floor Mounting E.W.C. to be fixed on the floor with help of Screwed and do not use Cement at the hollow portion of E.W.C.
4. It is recommended to clean regular with dry cloth / Mild Detergent to avoid stain & if required, diluted Hydrochloric acid may be used.
5. Do not use hard bristled / wire brush for cleaning to avoid scratches on wares.

TECHNICAL SPECIFICATION

PARTICULARS	I.S.I REQUIREMENTS	OUR VALUE
WATER ABSORPTION	< 0.5%	< 0.25%
MODULUS OF RUPTURE	> 600 KG/CM2	750 KG/CM2
CRAZING RESISTANCE (STEAM PRESSURE OF 3.7 KG/CM2 FOR 4 HRS)	NO CRAZING UPTO TWO CYCLES	NO CRAZING UPTO FOUR CYCLES
MINIMUM FIRED THICKNESS	SHOULD BE 6.0 MM AT ANY AREA	> 7 MM AT ANY AREA
WARPAGE	APPLIANCE SHOULD NOT EXCEED SPECIFIED LIMIT	WELL WITHIN IN PERMISSIBLE RANGE
THICKNESS OF GLAZE AT ANY PLACE	NOT SPECIFIED	400 MICRONS (0.4 MM)
SURFACE QUALITY	NO WAVY FINISH ON VISIBLE SURFACE	NO WAVY APPEARANCE
DISCOLOURATION	NONE ON VISIBLE SURFACE	NONE
RESISTANCE TO CHEMICALS	SHOULD BE RESISTANT TO ALL HOUSE HOLD CHEMICALS	PASSES
RESISTANCE TO STAINS AND BURNS	NO STAIN SHOULD REMAIN ON TESTING	PASSES

TROUBLE SHOOTING GUIDE

ITEM	PROBLEM	PROBABLE REASONS	CORRECTIVE ACTIONS
One piece Closet	1. Water not coming in bowl area while flushing	Water line not cleaned properly	Before installation clean the incoming as well as out going line
		Malfunctioning of Mechanism inside tank	Change the mechanism
		No water in the flush tank	Raise the height change slot to the max. level
	2. Leaking of water in bowl area	Push button is locked	Release the push button
Fitment of mechanism end part and outlet of tank not fitted properly		After opening the mechanism check the fitment	
Malfunctioning of Mechanism inside tank		Change the mechanism	
3. Insufficient Water quantity for effective flushing	Height change slot adjusted at lower level	Closet is not levelled properly	
4. Uneven flow of water from both side of closet	Raise the height change slot to the max. level	Level the closet properly	
Wall hung water closet	1. Water not coming in bowl area while flushing	Flush valve /concealed cistern is not working properly	Change flush valve / concealed cistern
		Flush pipe is not inserted up to the end of inlet hole	Insert the flush pipe upto the end of inlet
	2. Leaking of water in bowl area	Closet is not levelled	Level the closet properly
3. Insufficient Water quantity for effective flushing	Connection between closet outlet and drainage pipe is improper	Engage experienced plumber for proper connection	
Wash Basin/ Table Top	1. Overflow chocked and foul smell	Full threaded waste coupling might be in use	Replace it by slot cut coupling
	2. Water logging in platform and bowl area	Bracket and basin fixing may be the reason	Levelling to be checked and rectified
	3. No tap hole in the basin	Tap hole is semi punched from back side	Call plumber and open up the semi punched hole
EWC/Pan/ Anglo indian	1. Water not coming in bowl area while flushing	Flush bend is not inserted up to the end of inlet hole	Insert the flush pipe upto the end of inlet
		Levelling issue	To be levelled properly